

Pulsed Microwave Attacks on US, Canadian, Embassy and Security Personnel: The Havana Syndrome

havasynndrome.nl

Published: 9 June 2021 **Last update: 21 April 2024**

Download PDF: [Havana_Syndrome_STOPEG_20240421.pdf](#)

Peter Mooring, STOPEG Foundation www.stopeg.com

This is NOT a conspiracy webpage/document. It contains only quotes from and links to articles, images, videos from mainstream media websites such as CNN, The New York Times, NBC News, BBC News, Reuters, Politico, The Guardian, CBS News, ABC News, The Wall Street Journal, etc.

December 2023. I noticed that some mainstream media videos/articles have been removed. Ask yourself what could be the reason ...

Contents

1. Introduction

2. **Important** **Start here** What we know so far

- List of events (**latest**)
- What we also know
 - The Havana Act is discriminatory: It excludes domestic cases, ignores a lot of symptoms, focusses only on visible brain damage, and excludes civilians.
 - The Havana Syndrome is NOT caused by an unknown weapon.
 - How does it feel when you are attacked and there is no wound.
 - Also children (and pets) are attacked.
 - And there is no protection, not even in your own home.
 - These crimes can no longer be denied.
 - This has been going on for two, three decades.
 - Victims, diplomats and security officers, receiving compensation from the US government.
 - The US military is developing a wearable 'RF weapon' exposure sensor.
 - The U.S. military confirms 1. the existence of these weapons, 2. people can be attacked with these weapons.
 - The Havana Syndrome is only part of the crimes, atrocities, that are committed against civilians with Directed Energy Weapons.
 - 1 March 2023 is Havana Syndrome Cover-up Day.
 - The reason for the cover-up.
 - Ignore the Mass Psychogenic Illness theory.

- Interviews with US Diplomats, CIA-officers, describing Havana Syndrome attacks and symptoms.
 - List of Havana Syndrome symptoms
 - List of Havana Syndrome incidents by date and (geo)location
 - Summary
 - Timeline of Russia - US relations
3. **New** Articles and videos - March, April 2024
 4. Articles and videos - January, February 2024
 5. Articles and videos - November, December 2023
 6. Articles and videos - September, October 2023
 7. Articles and videos - July, August 2023
 8. Articles and videos - May, June 2023
 9. **Important** Declassified report suggests "Havana syndrome" could result from energy weapon - 29 March 2023
 10. Articles and videos - March, April 2023
 11. **Important** US intelligence community report finds Havana Syndrome not caused by foreign adversary - March 2023
 12. **Important** Targeted Justice files \$1.3 Billion lawsuit against the DOJ, FBI, & DHS.
 13. Articles and videos - January, February 2023
 14. Articles and videos - November, December 2022
 15. Articles and videos - September, October 2022
 16. C.I.A. Begins Compensating Victims of Havana Syndrome - August 2022
 17. Articles and videos - July, August 2022
 18. US to pay Havana Syndrome victims - June 2022
 19. Articles and videos - May, June 2022
 20. Articles and videos - March, April 2022
 21. **Important** 'Havana Syndrome' stumps investigators as U.S. officials report injuries on White House grounds - February 2022
 22. **Important** Declassified US intelligence community report says 'pulsed electromagnetic energy' could cause Havana Syndrome - February 2022
 23. Havana Syndrome like attacks on Paris, Geneva, US diplomats - January 2022
 24. Articles and videos - January, February 2022
 25. Mark Lenzi v. United States Department of State, and Antony J. Blinken - December 2021
 26. Articles and videos - November, December 2021
 27. Four Havana Syndrome diplomats got permission from the State Department to talk about their experiences - October 2021, December 2021
 28. Havana Syndrome like attacks on Bogota, Colombia, US embassy staff - October 2021

29. **Important** Biden signs bill giving Havana Syndrome victims better medical care - October 2021
30. Havana Syndrome like attacks on Serbia, CIA officer - September 2021
31. Ryan Conlon attempted to sue the CIA, DOD, Air Force for attacking him with Direct Energy Weapons citing the Havana Syndrome Act - September 2021
32. Havana Syndrome like attacks on India, CIA team member - September 2021
33. Articles and videos, September - October 2021
34. Havana Syndrome like attacks on Hanoi, Vietnam, US embassy - August 2021
35. Havana Syndrome like attacks on Berlin, Germany, US officials - August 2021
36. Articles and videos - July, August 2021
37. Havana Syndrome like attacks on Vienna, Austria, US diplomats - July 2021
38. Senate passes bill to aid Havana Syndrome attack victims - June 2021
39. Articles and videos - May, June 2021
40. Senate Intel leaders say mysterious directed energy attacks appear to be increasing - April 2021
41. US investigating possible mysterious directed energy attack near White House - April 2021
42. U.S. probing suspected directed-energy attack on government personnel in Miami - April 2021
43. U.S. troops increasingly vulnerable to directed-energy attacks, Pentagon tells lawmakers - April 2021
44. The Pentagon Fears That Deadly Microwave Weapons Are Undetectable - March 2021
45. Articles and videos - March, April 2021
46. Articles and videos - November, December 2020
47. Articles and videos - September, October 2020
48. An Assessment of Illness in U.S. Government Employees and Their Families at Overseas Embassies - 2020
49. CIA agents suspect they were attacked with microwave weapon in Australia - 2019
50. The US military is developing a wearable 'RF weapon' exposure sensor - 2019
51. Havana Syndrome Among Canadian Diplomats: Brain Imaging Reveals Acquired Neurotoxicity - 2019
52. Advanced Neuroimaging Shows Brain Matter Alterations in U.S. Government Personnel Who Developed Neurological Symptoms in Cuba - 2019
53. Is an invisible weapon targeting U.S. diplomats? - 2019
54. Canadian Cuba diplomats sue Ottawa for \$28M over health ailments during Cuba postings - 2019
55. Articles and videos - November, December 2018

56. Articles and videos - September, October 2018
57. Articles and videos - May, June 2018
58. Diplomat leaves post in China after reporting Havana Syndrome symptoms - 2018
59. Articles and videos - November, December 2017
60. Former CIA agent Marc Polymeropoulos victim of microwave weapon in Moscow - 2017
61. Canadian Cuba embassy staff attacks - 2017, 2018
62. USA Cuba embassy staff attacks - 2016, 2017
63. USA Consulate Guangzhou, China, staff attacks - 2016, 2017
64. Russia's zombie ray gun program - 2012
65. Unclassified - Bioeffects of Selected Nonlethal Weapons - 2006
66. The film 'Control Factor' (2003)
67. Mike Beck, a former NSA counterintelligence officer suspected he was exposed to microwave attacks - 1999
68. Wonder Weapons article in U.S News and World Report - 1997
69. Greenham Common women peace activists claim being attacked with microwaves - 1986
70. USA Moscow embassy staff microwaving - 1976
71. Laws prohibiting attacks with electromagnetic waves
72. Related documents: Medical
73. Related documents: Books and websites
74. Articles in Dutch
75. Contact

1. Introduction

I created this page to document that directed energy weapon attacks on people are very real. Weapons have been developed that are invisible, silent and often go through-wall. This page is mostly about the physical damage caused by these weapons. There is another category of weapons based on electromagnetic waves also used today that is even more terrifying and can attack our brain, or more specifically, our thoughts. I will create a separate document for this. If you want to read more about this:

- [Human Brain Project](#)
- [Dr. James Giordano: The Brain is the Battlefield of the Future \(video\)](#)
Please listen at least the beginning of this video.
And if you understand and dare to hear more truth skip to minute 37.
- [Dr. James Giordano: Battlescape Brain: Military and Intelligence Use of Neurocognitive Science \(video\)](#)
This is a 2020 follow up.

During the Cold War, the USA discovered that its embassy in Moscow was microwaved. This triggered a weapons race in deniable invisible weapons based on electromagnetic waves. The year was 1975. These weapons can attack the body and the brain. Some keywords: Directed Energy Weapons (DEW), Neuro weapons, Microwave weapons, Microwave hearing, Sonic weapons, Psychotronic weapons, Non-lethal weapons, Brain zapping.

It appeared that the human body and brain are extremely vulnerable to electromagnetic energy. For example, the human body can be heated and cooked with a microwave weapon. The heart can be stopped and you can be forced to vomit, urinate or defecate. The human brain (neurons) can be influenced by forcing voices (also known as microwave hearing), thoughts and emotions. Many ways have been discovered to attack a human being with these weapons.

After incidental reports, the USA sounded the alarm in 2016 when their diplomats and security personnel got attacked in China, Cuba and Australia. They called this the **Havana Syndrome**. The Havana Syndrome suggests an illness, but after some time experts could only conclude that these were symptoms of attacks with electromagnetic weapons. A number of Canadian diplomats who were also attacked in Cuba sued their government for \$28 Million, and, in contrast to their USA victims released much more details about these attacks. In this document I summarize these events and new events.

Weapons based on invisible (electromagnetic) radiowaves are the perfect weapons for individual control and group control. Attacks can easily be denied, and attacks can mimic known physical and mental symptoms. And once you have them, why not use them for personal gain?

These weapons are being developed and tested and used on real people. But governments keep silent. This is one of the best kept secrets in the world.

The government agencies using these weapons are trapped by their own crimes. They have always done research on people, done horrible things to people, but no one knew because there was no internet. They just got away with it. With the internet, for the first time in history, survivors could put their stories online for everyone to read.

Havana Syndrome is not a disease but a name for symptoms of attacks with Directed Energy Weapons. These weapons are not new but have been around for many decades.

With the Havana Syndrome reaching the general public there is an opportunity for the US government to officially acknowledge that these Electromagnetic weapons exist AND are being used for over 2-3 decades. This would create a legal mess at least. But it also paves the way for a worldwide ban on EM weapons similar to the ban on Nuclear weapons.

If you still wonder why EM weapons must be banned like Nuclear weapons then let me give you some reasons:

- **On 21 July 2009 NATO chief De Hoop Scheffer suffered a heart attack. He was in Belgium on the Belgian National Day. He had heart surgery. On 26 July 2009 Sarkozy, President of France, fell down while running. We were told his heart went out of sync for a short period of time, nothing to worry.
How do we know if there were medical conditions that caused these heart problems or if EM weapons were involved?**
- **During a horse race, the favorite horse suddenly starts galloping. Through the betting shops, you can win a lot of money.
How do we know if the horse was exhausted or if EM weapons were involved?**
- **These weapons are not that difficult to build. No doubt, there are now criminal groups (not affiliated with government organizations) that use these weapons to make easy money and/or to 'take out' people (by contract or otherwise). And their number will only increase.**

Many civilians have been and still are tortured, or are subjected to testing, with Directed Energy Weapons. This is called 'mind control experimentation', see also MK-ULTRA. The survivors put their stories on the internet and call themselves Targeted Individuals. Many people suffer and many people die. This has been going on for decades and goes on today. These crimes are among the worst in history and are a disgrace to humanity.

2. What we know so far

In this section I summarize what we know based on the information in recent main stream media articles mentioned on this page.

List of events

- Microwave weapons are with us since the 1960's.
- In 1961, the American neuroscientist Allan H. Frey was the first to publish information on the nature of the microwave auditory effect, also known as the microwave hearing effect or the Frey effect. The effect consists of the human perception of audible clicks, or even speech, induced by pulsed or modulated radio frequencies. Researchers reported that they were able to recognize nine out of ten words transmitted by "voice modulated microwaves".

- Between the 1950s and 1970s, the U.S. Embassy in Moscow was beamed with microwaves, prompting health concerns and the United State's then-classified exploration of such weaponry.

- Mark S. Zaid, a lawyer representing some of the Havana Syndrome victims, has a CIA briefing slide appearing to date from the 1960s or 1970s which shows a building being hit by microwaves from a nextdoor structure. Zaid said the slide was among the personal effects left by a deceased agency officer.



- In 1977, during the MKULTRA hearings, Dr. Geschickter testified there was a CIA project involving microwaves (p.90): 'The other, which was funded through this later business was **the use of radar to put monkeys to sleep**, to see if they could be, should I say, instead of Mickey Finn, they could put them under with radar directed toward the monkey brain.' Senator Schweiker: 'Could they?' Dr. Geschickter: 'Did they go to sleep?' Senator Schweiker: 'Yes.' Dr. Geschickter: 'Yes, sir. But, Senator, it showed if you got into too deep a sleep, **you injured the heat center of the brain the-way you cook meat**, and there was a borderline there that made it dangerous.'

- In 1985, CNN published a Special Report, hosted by Chuck DeCaro, on Electromagnetic Mind Control Weapons. Dr. Robert Becker and Dr. Ross Adey show how electromagnetic fields and radio frequencies were tested as weapons of war against both machine and humans. Two videos:



- In 1990, in International Review Of the Red Cross, the article The development of new anti-personnel weapons, section Directed Energy Weapons (DEW) by Louise Doswald-Beck and Gerald C. Cauderay, mentions: In spite of the rarity of publications on this subject, and the fact that it is usually strictly classified information ... very small amounts of electromagnetic radiation could appreciably alter the functions of living cells. ... Unprotected soldiers within this zone could be put hors de combat or killed within a few seconds. Some research seems to have confirmed that low-level electromagnetic fields, modulated to be similar to normal brainwaves, could seriously affect brain function. Experiments with pulsed magnetic fields carried out in animals have reportedly produced specific effects such as inducing sleep and triggering anxiety or aggressiveness. Research work in this field has been carried out in almost all industrialized countries, and especially by the great powers, with a view to using these phenomena for anti-materiel or anti-personnel purposes.
- In 1997, U.S News and World Report published an article, by Douglas Pasternak, 'Wonder Weapons' that reveals that the U.S. had research projects
 - to incapacitate people without inflicting lethal injuries,
 - to affect human behavior,
 - to blind enemy soldiers,
 - to stun them, nauseate them,
 - or even "liquefy their bowels and reduce them to quivering diarrhetic messes,"

- to incapacitate the central nervous system remotely,
 - to make internal organs resonate (the effects can run from discomfort to damage or death),
 - to induce epilepticlike seizures,
 - to heat the body to bring on discomfort, fevers, or even death,
 - to alter sleep patterns,
- using lasers, acoustics and microwaves.

- In 2003, January, the film 'Control Factor' was released. The main character Lance was hearing voices that told him to murder his wife Karen. Later in the film his wife appeared to be an agent, her real name in the film was **Medusa**. The film shows a (secret) government agency experimenting on civilians with the aim to control everyone. Control Factor. See also: MEDUSA (weapon), MEDUSA (Mob Excess Deterrent Using Silent Audio), Microwave ray gun controls crowds with noise.

- In 2003, the document BIOLOGICAL EFFECTS OF ELECTROMAGNETIC RADIATION (RADIOWAVES AND MICROWAVES - EURASIAN COMMUNIST COUNTRIES, DEFENSE INTELLIGENCE AGENCY, **dated March 1976**, was obtained through a FIOA request. This document was shown in 2021 in a report by CNN about the Havana Syndrome.

- In 2004, there was a page on the website of the US Navy (deleted now) that discloses a project with the codename **Medusa**, a prototype of a microwave weapon made for the Marine Corps in 2004 which had a 'temporarily incapacitating effect' and was small enough to fit in a car: Remote Personnel Incapacitation System

→ AWARD DETAILS

Contract #	M67854-04-C-1012
Topic	N03-163
Solicitation	03.2
SYSCOM	MARCOR
Award Amount	99965.00
Phase	I
Program	Navy SBIR
Start / End Date	11/19/2003 - 05/19/2004
FY Reported	2004
Title	Remote Personnel Incapacitation System

→ SUMMARY INFORMATION

Objective of Phase Effort

The main goal of the Phase I project was to design and build a breadboard prototype of a temporary personnel incapacitation system called MEDUSA (Mob Excess Deterrent Using Silent Audio). This non-lethal weapon is based on the well established microwave auditory effect (MAE). MAE results in a strong sound sensation in the human head when it is irradiated with specifically selected microwave pulses of low energy. Through the combination of pulse parameters and pulse power, it is possible to raise the auditory sensation to the "discomfort" level, deterring personnel from entering a protected perimeter or, if necessary, temporarily incapacitating particular individuals.

Summary of Results from the Phase I Effort

The major results of the Phase I effort were that - An operating frequency was chosen - Hardware requirements were established (commercial magnetron, high-voltage pulse former) - Hardware was designed and built - Power measurements were taken and the required pulse parameters confirmed - Experimental evidence of MAE was observed

Potential Applications and Benefits

Potential applications of the MEDUSA system are as a perimeter protection sensor in deterrence systems for industrial and national sites, for use in systems to assist communication with hearing impaired persons, use by law enforcement and military personnel for crowd control and asset protection. The system will: be portable, require low power, have a controllable radius of coverage, be able to switch from crowd to individual coverage, cause a temporarily incapacitating effect, have a low probability of fatality or permanent injury, cause no damage to property, and have a low probability of affecting friendly personnel.

Taxonomy

→ PHOTOGRAPH/GRAPHIC

- In 2006, Donald Friedman received, through a FOIA request, the document 'Bioeffects Of Selected Non-Lethal Weapons' from the Department of the Army. This document, **dated 17 February 1998**, describes in detail the effects on the human body when applying laser light, radio frequency directed energy, and bio sound effects:
Radio frequency directed energy to create:
 - microwave heating,
 - microwave hearing,
 - disruption of neural control including a sudden loss of consciousness and intense muscle spasms,Acoustic energy to create:
 - severe pressure sensations,
 - involuntary motion of the eyes,
 - nausea and seeing his surroundings turning around him.

Laser light to create:

- dazzling or induced glare,
- flashblinding or loss of night adaptation,
- permanent or semipermanent blinding.

~~SECRET~~ ~~NOFORN~~ **UNCLASSIFIED**

Bioeffects of Selected Nonlethal Weapons(fn 1)

This addendum to the Nonlethal Technologies--Worldwide (NGIC-1147-101-98) study addresses in summary, some of the most often asked questions of nonlethal weapons technology, the physiological responses observed in clinical settings of the biophysical coupling and susceptibility of personnel to nonlethal effects weapons. These results identify and validate some aspects of maturing nonlethal technologies that may likely be encountered or used as nonlethal effectors in the future including:

- Laser and other light phenomena.
- Radiofrequency directed energy.
- Aural bioeffects.

The study of electromagnetic fields and their influence on biological systems is

- In 2006, NATO published the report The Human Effects of Non-Lethal Technologies.
- In 2006, 12 September, Air Force Secretary Michael Wynne said: Nonlethal weapons such as high-power microwave devices should be used on American citizens in crowd-control situations before they are used on the battlefield.
- In 2007, Wired Magazine published a number of articles by Sharon Weinberger, about weapons that can shoot an invisible wall-penetrating beam (zapping through walls) that makes people so dizzy they fall over, that can make you puke (vomit beam), fart, or lose control of your bodily functions .

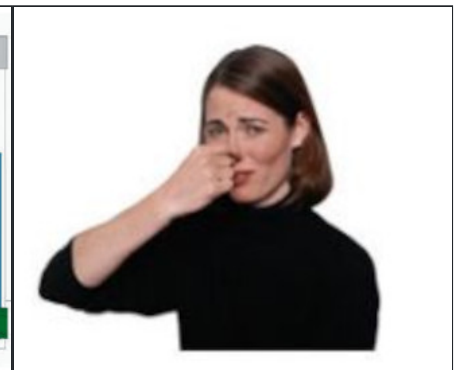
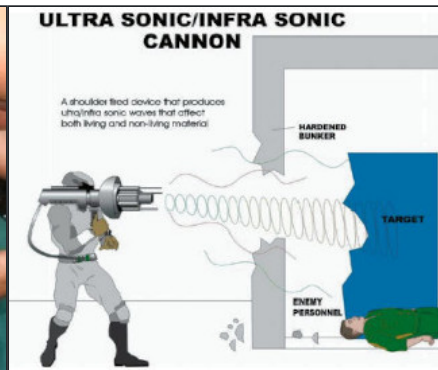

- In 2008, the U.S. military demonstrated the Active Denial System (ADS), also called the heat ray or ray gun, a Directed Energy Weapon, that works by heating the skin of targeted human beings using millimeter waves (95 GHz). An overdose can result in second-degree

burns. The Air Force Research Laboratory (AFRL) finished testing the system on human volunteers already in 2001.

- In 2013, Chinese researchers found that rats exposed to pulsed microwaves had difficulty in learning to negotiate a water maze for up to three days after exposure. The researchers believed this was due to damage to the hippocampus, a part of the brain associated with memory.

- In 2014, January, an article in Radioelectronics Nanosystems Information Tech, Electromagnetic systems and means of deliberate impact on physical and biological objects, contained the section: TOOLS OF INTENTIONAL ELECTROMAGNETIC IMPACT ON A HUMAN.

Maximum sensitivity of brain tissue, regulation of biorhythms (6-20 Hz frequency EMF, level of 10 W/cm ²) →		← Resonance with biocurrents brain, dysfunction of heart muscle (300-700 Hz frequency EMF, level of 10 W/cm ²)
The heating of deep parts of the brain, the heating of the temporal lobes, hemodynamic disturbances in peripheral circulation (300-1200 MHz frequency EMF, level of 100 mW/cm ²) →		← Jump of conductivity biological tissue (10-100 kHz frequency EMF, level of 10 W/cm ²)
Instability of the pulse, changes in systolic blood volume, blood pressure, peripheral vascular spasm (460 MHz frequency EMF, the level of 50 mW/cm ²) →		← The effect of "string of pearls" - alignment of erythrocytes and leukocytes in field (EMF frequency 1-100 MHz, level of 100 W/cm ²)
Greatest impact on central nervous system; after prolonged exposure, a violation of a regular function of higher vegetative organs (10-100 GHz frequency EMF, level of 10 mW/cm ²) →		← Changing level of EEG (1-100 MHz frequency EMF, level of 0.1 W/cm ²) ← Pain threshold for cutaneous receptors (EMF frequency 20 GHz, level of 100 mW/cm ²)

Fig. 2. Characteristics of bioeffects, caused by energetic impact to EMF on humans.

- In 2014, the NSA more or less confirms that agents already were attacked with microwave weapons in the 1990's:
'The National Security Agency confirms that there is intelligence information from 2012 associating the hostile country to which Mr. Beck traveled in the late 1990s with a high-powered microwave system weapon that may have the ability to weaken, intimidate, or kill an enemy over time and without leaving evidence.
The 2012 intelligence information indicated that this weapon is designed to bathe a target's living quarters in microWaves, causing numerous physical effects, including a damaged nervous system. The National Security Agency has no evidence that such a weapon, if it existed and if it was associated with the hostile country in the late 1990s, was or was not used against Mr. Beck.'
Mark Zaid on 11 April 2023: 'This document was very carefully crafted by my colleagues inside the legal office in NSA because they were giving it to me for use in potential proceedings to try and get medical attention for Michael Beck.'



UNCLASSIFIED//FOR OFFICIAL USE ONLY
NATIONAL SECURITY AGENCY
FORT GEORGE G. MEADE, MARYLAND 20755-6000

October 16, 2014

(U//FOUO) The National Security Agency confirms that there is intelligence information from 2012 associating the hostile country to which Mr. Beck traveled in the late 1990s with a high-powered microwave system weapon that may have the ability to weaken, intimidate, or kill an enemy over time and without leaving evidence. The 2012 intelligence information indicated that this weapon is designed to bathe a target's living quarters in microwaves, causing numerous physical effects, including a damaged nervous system. The National Security Agency has no evidence that such a weapon, if it existed and if it was associated with the hostile country in the late 1990s, was or was not used against Mr. Beck.

- In 2015, Major General Jerry Harris, vice commander of Air Combat Command, said the Air Force had developed a high-power microwave weapon that could disperse crowds without killing people by rapidly raising body temperature, and the system could be put to use immediately on drones or other aircraft.
- In 2015, scientists in Tokyo carried out tests on rats, using intense pulsed power to cause microwave-induced traumatic brain injury. When they examined the damage to brain tissue afterwards, they concluded that "microwave-induced neurotrauma shows the same pathological changes as blast traumatic brain injury." In other words, it is possible to produce concussion inside the skull with microwave pulses, exactly as seen in Havana Syndrome.
- In 2016, December, the US government passed the Directed Energy Weapon Systems Acquisition Act of 2016. From this document: "the term 'directed energy weapon system' means military action involving the use of directed energy **to incapacitate, damage, or destroy enemy equipment, facilities, or personnel.**"
- **START OF HAVANA SYNDROME INCIDENTS**
- In 2016, December, Patient Zero, a CIA officer operating under diplomatic cover, visited the Embassy health office telling he had experienced strange sensations of sound and pressure while in his home, followed by painful headaches and dizziness.
- In 2016, U.S. government employees working at the U.S. Embassy in Havana, Cuba, suddenly started suffering from dizziness, fatigue, headaches, loss of hearing, memory and balance. Their children suddenly fainted and had massive nose bleeds. The Canadian embassy staff in Havana, Cuba, including their children, experienced the

same symptoms. They were relocated to the U.S. and Canada and investigations were started.

- In 2017, a CIA doctor investigating the mysterious Havana syndrome says he got symptoms of the illness himself and is five years later, still struggling with debilitating symptoms.

- In 2018, 1 September, The New York Times published an article Microwave Weapons Are Prime Suspect in Ills of U.S. Embassy Workers that summarizes events, history, statements from doctors, research teams, and experts. This article also mentions the microwave auditory effect and radio-frequency hearing, that can be created using pulses of radiofrequency (RF) energy.

- In 2018, 12 December, Dr. Michael Hoffer of the University of Miami and Carey Balaban, Ph.D, of the University of Pittsburgh present their findings: We found objective evidence of balance disorders ... Directed energy is basically what we say it is ...



- In 2019, February, a number of Canadian diplomats sue their government for \$28M over health ailments during Cuba postings. Havana Canada diplomats were also transferred back to Canada for assessment after experiencing attacks consistent with the Havana syndrome.

- In 2019, September, an article was published, Havana Syndrome Among Canadian Diplomats: Brain Imaging Reveals Acquired Neurotoxicity: Our findings confirm brain injury, specify the regions involved, and raise the hypothesis of overexposure to cholinesterase inhibitors as a plausible etiology.

- In 2019, 17 September, QinetiQ published a page on their website that the US military is developing a wearable 'RF weapon' exposure sensor. The mentioned requirements: "an

extremely small footprint in terms of space, weight and power (SWaP), very low cost, very low false positive rate, and easy to interpret." See also: [Wearable Radio Frequency Weapon Exposure Detector](#) .

- Experts agreed that US and Canada embassy staff in Cuba were attacked with (pulsed) microwaves, [James C. Lin, 2017](#), [Beatrice Alexandra Golomb, 2018](#), [National Academies of Sciences, Engineering, and Medicine, 2020](#).
- In 2020, Spring, from the document 'HIGH POWER MICROWAVE WEAPONS: DISRUPTIVE TECHNOLOGY FOR THE FUTURE': "... Pulsed-wave HPMs deliver a high power, short-duration pulses of microwave energy, and can provide precise targeting ...".
- In 2021, Dr. James Giordano said the culprit could be some form of ultrasonic or acoustic device; a rapidly-pulsed microwave; or a laser-based system.
 - Drugs alone: Unlikely
 - Ultrasonics: Very Possible/Probable
 - Electromagnetics: Wholly Possible/Highly Probable
 - Combinatory: Possible with (+) explanatory value

POTENTIAL CAUSES OF HAVANA SYNDROME

- **Drugs alone:** Unlikely
- **Ultrasonics:** Very Possible/Probable
- **Electromagnetics:** Wholly Possible/Highly Probable
- **Combinatory:** Possible with (+) explanatory value

JAMES GIORDANO

SOON ON CNN:
PENTAGON BRIEFING
ON AFGHANISTAN

DEVELOPING STORY

POSSIBLE HAVANA SYNDROME INCIDENT DELAYED HARRIS FLIGHT TO VIETNAM

LIVE

CNN

S&P 3.74

SUBSCRIBE

- The main stream media increasingly report that the weapons used are Directed Energy Weapons.
- U.S. diplomats and security personnel were also attacked in many other places including [China](#), [Paris and Vienna](#), [Berlin](#), [Australia](#), [London](#), [India](#), [Moscow](#), [Bogota](#). A number were also attacked in the United States itself, [even on the grounds of the White House in Washington](#).

- In 2021, 21 January, '... And so effectively there is no way to protect either soldiers or diplomats from this type of weapons unless they are completely encased in metal'. Professor Dr. Edl Schamiloglu of the University of New Mexico: Right. The following patent (**filed 2005**) was mentioned: ELECTROMAGNETIC PERSONNEL INTERDICTION CONTROL METHOD AND SYSTEM. This patent describes a device that operates **through walls** 'and provides an individual soldier or law enforcement officer with the ability to reduce an opponent to helplessness from a remote location while doing no permanent damage'.

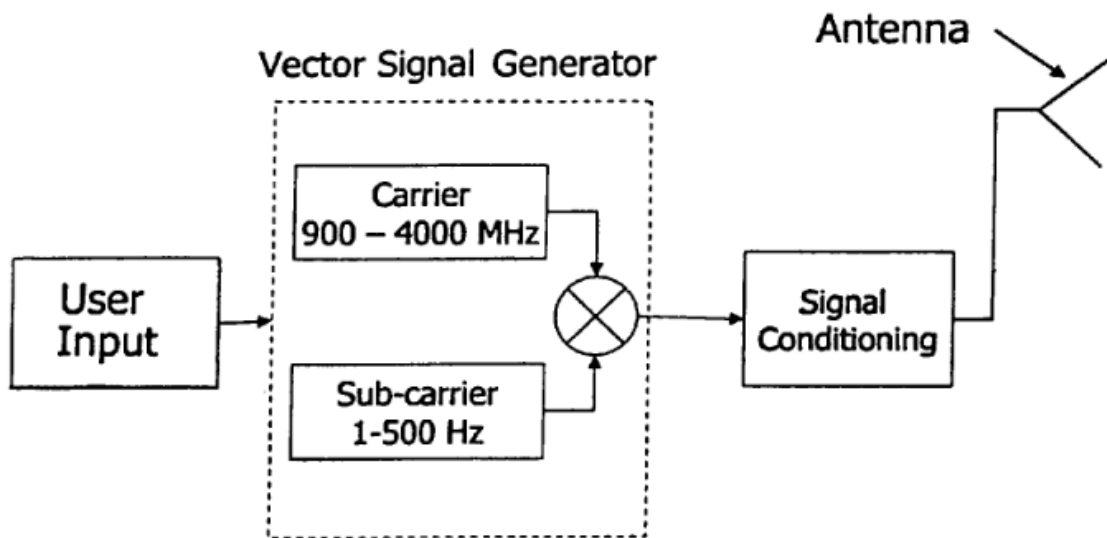

Fig. 10

- In 2021, 21 January, Robyn Garfield and several other victims founded an organization called Advocacy for Victims of Havana Syndrome, which fights for recognition of the plight they face.
- In 2021, May, US officials confirmed 130 incidents of Havana Syndrome brain injury.
- In 2021, 8 October, President Biden signs legislation, known as the HAVANA Act, to support and compensate victims of the Havana Syndrome.
- In 2021, 7 December, the Washington Examiner reported that in 2007 former President George W. Bush, former first lady Laura Bush, and staff members, experienced symptoms consistent with the Havana Syndrome symptoms while in Germany for that year's G-8 summit.
- In 2021, 28 December, President Biden signs off off on \$30 million in funding for victims of the Havana Syndrome, officials believe is caused by directed-energy attacks.
- In 2022, 21 January, Mark S. Zaid, a Washington DC based attorney who represents several of those affected: 'It started long before Havana,' Zaid said. 'It was just those incidents that

brought it to light.'

- In 2022, 2 February, the US intelligence community released a report that concludes that the Havana Syndrome symptoms probably are caused by ultrasound and pulsed microwave energy. The report also mentions that microwaves propagate through building materials and that psychosocial factors - which include work demands, stress and depression - cannot alone account for the core symptoms.

The image is a screenshot of an NBC News website article. The main headline reads: "'Havana Syndrome' symptoms in small group most likely caused by directed energy, says U.S. intel panel of experts". Below the headline is a quote: "Injuries suffered by several dozen diplomats and spies were consistent with directed energy, the panel said. About 1,000 people have reported symptoms." A large white box contains another quote: "Injuries suffered by several dozen diplomats and spies were consistent with directed energy, the panel said." Below the quote is a photograph of a building in Havana, Cuba. The article is by Ken Dilanian and dated Feb. 3, 2022. The NBC News logo and 'NBC NEWS NOW' branding are visible. The page layout includes a navigation bar at the top with categories like 'JAN. 6 HEARING', 'DECISION 2022', and 'WAR IN UKRAINE'. A sidebar on the right lists 'UP NEXT' stories, including 'PGA Tour suspends 17 players for participating in Saudi-backed LIV Golf event' and 'Five marines killed in Osprey aircraft crash outside San Diego'.

- In 2022, 20 February, 60 Minutes published a report that the ones operating these weapons not only attack adults but their children as well.

60 MINUTES OVERTIME >

The youngest victims of "Havana Syndrome"

60
MINUTES
Overtime

BY BRIT MCCANDLESS FARMER, MICHAEL REY & ORIANA ZILL DE GRANADOS
FEBRUARY 20, 2022 / 7:07 PM / CBS NEWS



- In 2022, March, John Bolton, National Security Advisor to President Donald Trump from April 2018 to September 2019: It was an attack I don't think there's any other hypothesis when you begin to look at the number and the pattern that we've experienced.

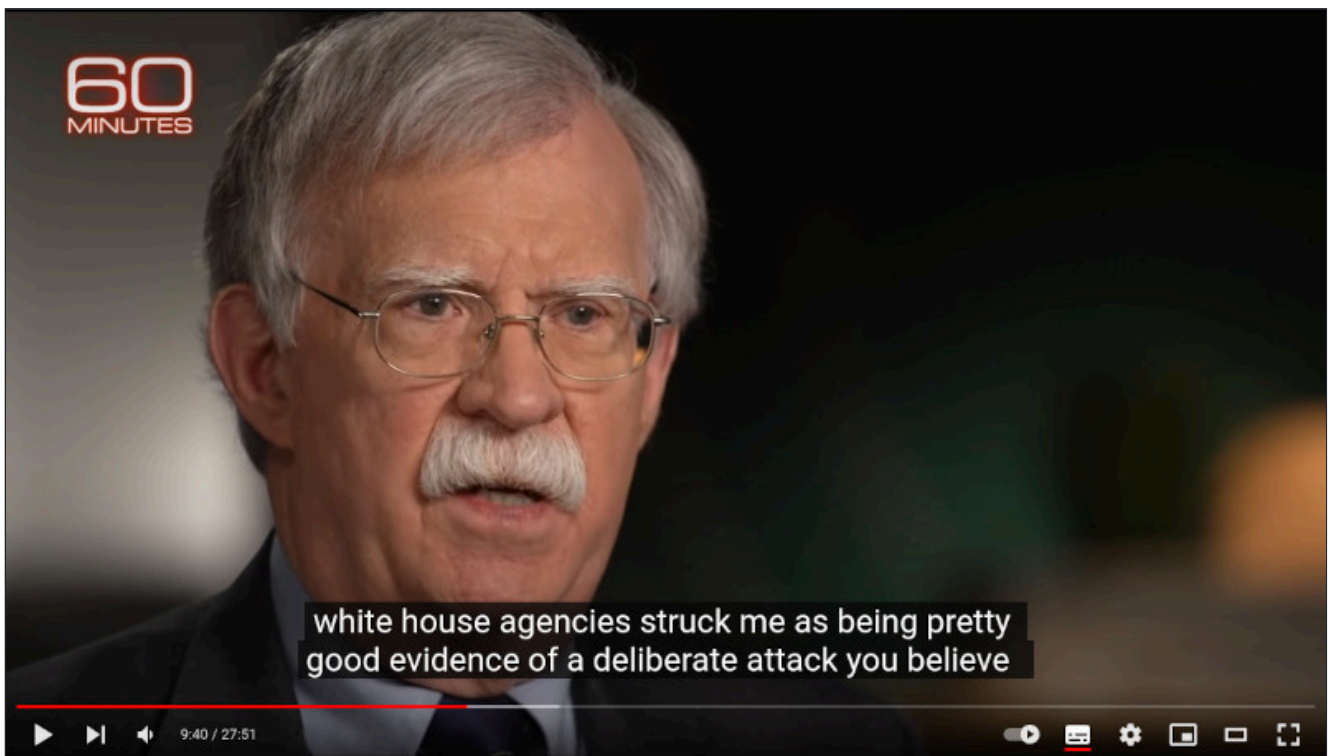

- In 2022, March, James Benford, a physicist and leading authority on microwaves, says the most plausible explanation is that it is a high power microwave weapon. 'There are many kinds and they can go anywhere in size from a suitcase all the way up to a large fracture trailer unit. Microwaves go through glass, they go through brick, they go through practically everything. The technology has been studied for more than fifty years. It has

been developed widely in perhaps a dozen countries. Primary countries are the United States, Russia and China.'

- In 2022, April, in IEEE Microwave Magazine, James C. Lin: The required microwave technology is mature and, in general, commercially available in many developed countries or military powers. Longer distances and higher-power scenarios would require more bulky equipment and sophisticated aiming devices, but packable equipment is possible for closer-range nonlethal applications.
- In 2022, June, the State Department is preparing to compensate victims of the Havana Syndrome, according to a Rule by the State Department called the Implementation of HAVANA Act of 2021.
- In 2022, August, the C.I.A. begins compensating victims of the Havana Syndrome.
- In 2022, August, Mark S. Zaid reveals that FBI personnel have been reporting symptoms of the mysterious syndrome that first afflicted overseas diplomats and spies... inside the US. Members of the FBI say they've been injured in DC and Florida, especially in the bureau's Miami field office.. 'There have been double digits of members of the FBI who have been injured on multiple locations inside the United States.'
- In 2022, 16 September, Mark S. Zaid says he knows what it is: 'This is gross evidence of a coverup by the US government. I have had access to classified information. And there is a lot of information that has not been publically revealed. And if you knew what it is, you would be very upset. I know that for a fact. Can't say what it is unfortunately. So it really sucks. I'm saying something I can't back it up.'
Listen to the audio fragment (mp3).
- In 2022, 20 November, an article 'CIA experiments or electromagnetic attacks from Russia?' appeared on MSN.com, that summarizes the Havana Syndrome. This article also mentions there are thousands of U.S. citizens who call themselves "targeted individuals" who've reported similar experiences, but they've been derided as paranoid and delusional.
- In 2023, 20 February, Nicky Woolf asks James Giordano the following question: 'Is there a type of microwave weapon out there that can cause this specific symptom profile that the victims in Havana experienced? That means something capable of not just causing the headaches, nausea, hearing and vision impairments, cognitive problems, even brain damage and all that - but also do it in this precisely targeted way?' James Giordano: 'Yes'.
- In 2023, 1 March, the US Intelligence Community released the report 'Updated Assessment of Anomalous Health Incidents', and investigative efforts. The main finding is that, *with high probability*, the Havana Syndrome is not caused by a foreign adversary. And that there there is *no credible evidence* that a foreign adversary has a

weapon that can cause these effects. (Pay attention to the wording).

The report does **not** specify which agencies took part.

Also from this report: 'Two agencies judge that deliberate causal mechanisms are unlikely to have caused AHIs and have low confidence because **they judge that radiofrequency (RF) energy is a plausible cause for AHIs, based in part on the findings of the IC Expert Panel and the results of research by some US laboratories.** All agencies acknowledge the value of additional research on potential adversary capabilities in the RF field, in part because there continues to be a scientific debate on whether this could result in a weapon that could produce the symptoms seen in some of the reported AHI cases.'

Avril Haines, Director of National Intelligence: "Needless to say, these findings do not call into question the very real experiences and symptoms that our colleagues and their family members have reported".

Karine Jean-Pierre, White House Press Secretary: "The work is ongoing".

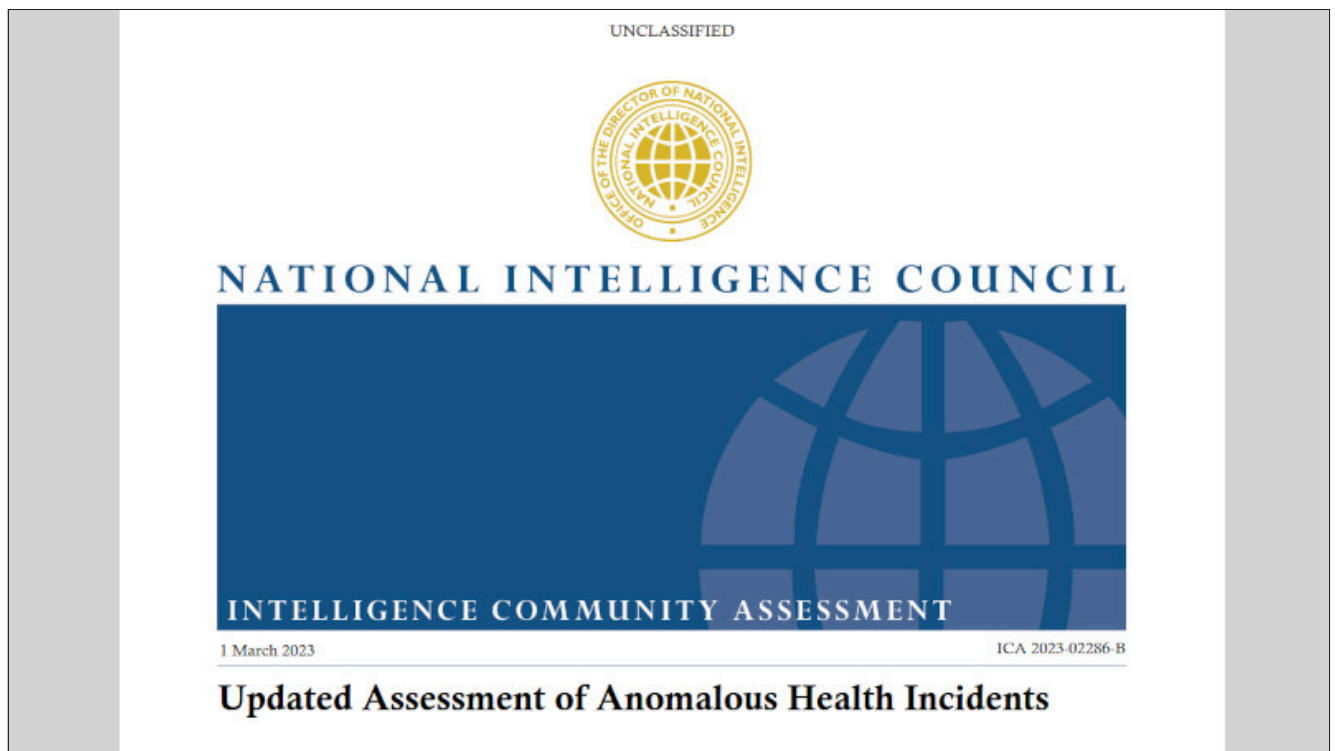

- Responses to the 1 March 2023 US Intelligence Community report:
 - On 1 March 2023, Mark S. Zaid, who's firm represents more than two dozen federal AHI victims from within the Intelligence, Military, Law Enforcement and Diplomatic communities who experienced incidents domestically and overseas....: ... The latest U.S. intelligence assessment lacks transparency and we continue to question the accuracy of the alleged findings....
 - On 1 March 2023, NBC News: 'They (US Intelligence Community) really don't have good answers, except that they tell us what did not happen.'
 - On 2 March 2023, Senator Marco Rubio: "As I have said before, something happened here and just because you don't have the answers, doesn't mean that it didn't happen. I will not accept that all these reported cases were just coincidences and I will continue to work on this issue until we receive real explanations."

- On 2 March 2023, Dr. James Giordano: ... the report blatantly disregards the accumulated scientific and forensic analysis and evidence of possible, if not probable, cause, specifically specifically for those individuals who are working in Havana ...
On 10 March 2023, a detailed reaction of Giordano was published: VIEWPOINT: Intel Community's Havana Syndrome Report and its Flawed Assumptions.
- On 2 March 2023, Havana Syndrome Patient Zero (Adam): ... To say that a foreign adversary doesn't have the same sort of technology or equipment is just laughable ...
- On 7 March 2023, Miles Taylor, former chief of staff of the Trump administration Department of Homeland Security: There is still an unsolved mystery here and it can't be explained as just sort of mass delusion because again, we have physical evidence ...
- On 10 March 2023, Marc Polymeropolous: I don't put a lot of credit in this report. ... I feel betrayed. There seems also to be a difference between what was briefed at the DNI and actually what's in the content of the, the actual assessment. ... Whereas what I've been told is that DOD is not on board with this. .
- On 13 March 2023, a top scientist who dealt directly with victims of Havana Syndrome – and their patients – remain convinced that the mysterious condition was caused by directed energy weapons: guns firing intense ultrasound, radio or microwaves: 'There's no environmental cause that causes the body damage that I saw. ... And I don't know how you create damage inside of a body, like what was seen, that comes on all of a sudden, and could be called 'pre-existing conditions'.

- In 2023, 7 March, Politico reported that the Havana Syndrome has affected more than 1,000 US government employees over the past several years. Besides the American diplomats at the U.S. embassy in Havana, hundreds more U.S. government personnel have reported similar incidents since then in locations worldwide, including China and Europe. Many victims and experts still believe they result from a directed-energy weapon.

- In 2023, 9 March, Politico reported that the Department of Defense is funding experiments on animals to determine if radio frequency waves could be the source of the mysterious ailment referred to as "Havana Syndrome".

- In 2023, 13 March, Ken Jones, a former FBI officer, told he was attacked in 2011 in a former Soviet country, with symptoms consistent with the Havana Syndrome.

- In 2023, 22 March, Mark Lenzi, a State Department security officer who worked in the U.S. Consulate in Guangzhou, China, reached a settlement with the US State Department over allegations that the government discriminated against him because of his new-found disability. State Department Will Pay \$460K to End Havana Syndrome Lawsuit.

- **In 2023, 29 March, the law firm of Mark S. Zaid obtained through FOIA litigation a declassified copy of the Intelligence Community's Expert Panel Report on Anomalous Health Incidents. The report suggests the "Havana Syndrome" could result from an energy weapon. From the report: 'Electromagnetic energy, especially pulsed signals in the**

radio frequency range, plausibly explains the main features, although there are gaps in information. There are several plausible paths associated with forms of electromagnetic energy, each with its own requirements, limitations and unknowns. For all pathways, there are sources that can generate the required stimuli, are latent, and require moderate power.'

Mark S. Zaid: No way this can be reconciled w/recent IC Assessment conclusions. AHIs are real & caused by human actors.

(U) (b)(3) FIGURE 8

Electromagnetic Pathways Involve Diverse Signal Parameters and Biological Effects

(b)(3) The five pathways involving electromagnetic energy considered by the Panel require a range of signal parameters and cause disparate effects on cells, tissues,

and organs. This table shows parameters for pulsed signals, although continuous signals could also be used for some pathways.

(U) This table is (b)(3)

Pathway	Peak Power (Field Strength)	Primary Frequency	Duration of Single Pulse (Pulse Repetition Frequency)	Biological Effects
Bulk heating	$> 10^3$ mW/cm ² ($>$ few kV/m)	~ 200 MHz to < 6 GHz	Any duration or repetition rate, including continuous wave signals	Heat and tissue damage. Higher frequencies penetrate and heat less deeply than lower frequencies.
Thermo-acoustic	10^2 to 10^5 mW/cm ² (50 to 200 kV/m)	~ 200 MHz to 3 GHz	≤ 5 μ s (~ 1 Hz to 1 kHz)	Pressure wave and possible traumatic brain injury. May hear clicking. Lower frequencies penetrate

- In 2023, 11 April, Mark Zaid in the SpyCast "'Havana Syndrome" – A Panel featuring Nicky Woolf, Marc Polymeropoulos, and Mark Zaid': How long has the Executive Branch known this was happening? To what extent were they telling anyone it was happening, a la what Kissinger was referencing? And what were the long-term health effects of it happening? And the responses that came out, the answers were, oh, it's been going on for 15, 20 years. We knew it in the Executive Branch. We weren't telling our people that it was happening who were based there in Moscow. And we have no idea of the long-term health impact because not enough time has gone by in 1977 or '9, whenever the -- the hearing was, because it had only been a few years that some of these people had been impacted. And why is it that that's not being studied? Why is it there's no report on that?

- In 2023, 18 April, experts criticize the Intelligence Community's Expert Panel Report. IC report: 'There is no credible evidence that a foreign adversary has a weapon or collection device that is causing AHIs [Anomalous Health Incidents]'. James Benford: 'It is false, that statement is false, ... and verifiable false. That sentence is definitively disinformation. ... it looks like a cover-up.' Edl Schamiloglu, University of New Mexico, sides with James Benford.

- In 2023, 26 April, affected diplomats and intelligence personnel, from the US and Canada, criticize the Intelligence Community's Expert Panel Report: 'Knife in the back': Havana

Syndrome victims dispute report dismissing their cases. Three former CIA officials and two Canadian diplomats affected said they are convinced they were targeted while serving their countries abroad. All said that the 1 March 2023 Intelligence Community report is an attempt to whitewash the Havana Syndrome affair, likely due to political considerations. Most requested anonymity out of fear of retaliation, concerns for their security or because they are not authorized to speak publicly about the cases.

- In 2023, 8 August, the government of India has agreed to investigate the possibility of the presence of the Havana Syndrome in India. . The petition was filed by A Amarnath Chagu, a resident of Bengaluru, who sought an inquiry into the syndrome in India and measures to prevent its transmission within the country.
- In 2023, 10 August, a federal court in New York denied the New York Times and the FBI's competing motions for summary judgment in the paper's request for a copy of an FBI Behavior Analysis Unit report on the "Havana syndrome" phenomenon. The FBI hasn't shown why it shouldn't be disclosed, but in camera review must first be conducted prior to release.
- In 2023, 27 September, Mark Zaid: Beyond the intelligence community, a lower dose of the microwave technology is currently being deployed throughout the United States by local law enforcement for crowd control and crowd disbursement.
- In 2023, 4 November, Nicky Woolf at EU for You at 5m26s: ... the problem is that these type weapons we discovered do exist ... with the specifications to do exactly what we're describing kind of long range directed energy to cause neurological damage, we found the training manuals, we know Lockheed Martin makes one, we know Raytheon makes one, we know there's a Chinese equivalent, we know there's a Russian equivalent, we know

Australia has bought the Lockheed Martin one ...



- In 2023, 16 November, a PETA article mentioned that a U.S. Army experiment involving bombarding 48 ferrets with radio waves in order to induce brain injuries, ended on March 10, just one day after the release of a Politico exposé highlighting PETA’s opposition.
- In 2023, 30 November, the U.S. military confirms 1. the existence of these weapons, 2. people can be attacked with these weapons. From the official website of the Defense Health Agency (DHA), a component of the Military Health System, **'An AHI is a counterintelligence incident.'** Anomalous Health Incidents (a.k.a. Havana Syndrome) or here. More than 1,000 U.S. diplomats and security personnel have reported these symptoms.
- In 2024, 17 January, an article by Omid Yaghmazadeh was published: Pulsed High-Power Radio Frequency Energy Can Cause Non-Thermal Harmful Effects on the BRAIN.
- In 2024, 11 March, after revelations by Michael Shellenberger, that CIA Director, Brennan “had identified 26 Trump associates” for the “Five Eyes” intelligence-aligned nations—the United States **surveillance and targeting**, Jim Jordan, Chairman Committee on the Judiciary, and Michael R. Turner, Chairman Permanent Select Committee on Intelligence, wrote a letter to William J. Burns, Director Central Intelligence Agency, requesting the release of all related documents and communications.
- In 2024, 18 March, the NIH (National Institutes of Health), published a News Release about two new studies that stated that the NIH found “no significant” evidence of brain injury or

biological abnormalities among those reporting symptoms.



NIH National Institutes of Health
Turning Discovery Into Health

Search NIH

Health Information Grants & Funding News & Events Research & Training Inst

Home - News & Events - News Releases

NEWS RELEASES

Monday, March 18, 2024

NIH studies find severe symptoms of “Havana Syndrome,” but no evidence of MRI-detectable brain injury or biological abnormalities

Compared to healthy volunteers, affected U.S. government personnel did not exhibit differences that would explain symptoms.

- Responses to the 18 March 2024 NIH News Release:
 - On 18 March 2024, David A. Relman writes in a response that he is far from convinced that the NIH studies are the end of the story. He decries lack of detailed info on bioeffects of EM & acoustic energy on the brain despite >60 yrs of interest: "... The experience with AHIs provides valuable lessons for clinicians, the scientific and national security communities, and national and international policymakers. **We ignore them at our own, collective peril.**" [Neurological Illness and National Security Lessons to Be Learned](#).
 - On 18 March 2024, Mark S. Zaid: "... The question must be asked: how can these facts be reconciled with these study conclusions that effectively say 'nothing there'? **The USG must declassify what it knows about AHI to ensure accountability and truthfulness.**" [STATEMENT OF MARK S. ZAID. ESQ.](#)
 - On 18 March 2024, Richard Stone - Science.org: "... **But that's like comparing “apples with artichokes,”** says Douglas Smith, director of UPenn's Center for Brain Injury and Repair and a co-author of the 2019 JAMA report. "The new studies include such different cohorts, timelines, and locations of purported exposures from ours that they cannot possibly be considered as replication studies," he says. [Mystery illness among U.S. diplomats did not cause permanent brain damage](#).
 - On 19 March 2024, Nora Gámez Torres - Miami Herald, wrote: "... Before the papers were published, Tim Bergreen, a lawyer with the firm Hogan Lovells, sent an email to JAMA's editorial board and the NIH Director of Research Integrity with a document listing several concerns from some of the study's participants. Bergreen did not immediately respond to a request for comment. **Bergreen's complaint, obtained by the Herald, includes allegations that NIH officials and researchers involved in the study maintained close contact with the CIA and were pressured to “ensure the studies**

'found' what was asked of them." The email says that doctors involved in the study made private remarks to patients that they were pressured or were afraid to report a traumatic brain injury diagnosis accurately, and that patients were told verbally of findings that were not later reported in writing in their medical records...." A study found no brain injuries linked to Havana Syndrome. Participants question the research. Tim Bergreen, Hogan Lovells.

- On 19 March 2024, Marc Polymeropoulos, referring to the Miami Herald article: Superb overview, including details on the flawed NIH study, lack of ethics by the doctors and USG, and perhaps even criminal behavior by the USG in forcing patients to go to NIH essentially as lab rats, prior to being accepted for treatment at Walter Reed. A stain on the USG.
- On 19 March 2024, Nathaniel Dove - Global News: "... He (the lawyer for the Canadian diplomats) said the study took place too long after diplomatic staff and family members reported the onset of symptoms, that examining patients beyond Cuba did not give accurate findings on those who say they began experiencing symptoms in Havana and that the report did not have data on the affected people's physical baselines before they began experiencing the symptoms..." U.S. 'Havana syndrome' reports raise concerns, Canadian diplomats' lawyer says, Canadian Diplomats Dispute Havana Study Findings.
- On 19 March 2024, Tom Rogan - Washington Examiner: "Again, Russia's Havana Syndrome hand is a secret only to those in the U.S. IC, military, and broader government who fear that admitting the truth will set them onto a new confrontation with Moscow. But the Russians are surely laughing at this continued American theatre of public confusion." As the Havana Syndrome scandal rumbles on, Nikolai Patrushev must be laughing.

- In 2024, 31 March, CBS 60 Minutes report '5-year "Havana Syndrome" investigation finds new evidence of who might be responsible, or, here, revealed an email of a Russian operative that might be linked to attacks on US diplomats.

2024 Игорьева Андрея Ивановича, действующего на основании Федерального закона от 16 октября 2012 г. № 174-ФЗ «О Фонде перспективных исследований» и Указа Президента Российской Федерации от 01 февраля 2013 г. № 47 «О генеральном директоре Фонда перспективных исследований», далее именуемый «Заказчик», с одной стороны, и Терентьева Ивана Николаевича Паспорт: 45 12 937693, выдан 31.01.2013 г. отд. УФМС России по г. Москве по району Хорошевский далее именуемый «Исполнитель», с другой стороны, вместе именуемые «Стороны», составили настоящий Акт о том, что в соответствии с п. 3.2 Договора передачи индивидуальной работы от «16» марта 2017 г. Исполнитель передал индивидуальную работу Заказчику на тему: **“Potential capabilities of non-lethal acoustic weapons...”** при военных (боевых) действиях в городе”.

«Сдал»

«Принял»

Исполнитель:

Заказчик:

Генеральный директор
Фонда перспективных исследований

- In 2024, 31 March, Mark Zaid in the CBS 60 Minutes report 'Havana Syndrome mystery continues as a lead military investigator says bar for proof was set impossibly high', or, here : So I've had access to classified information relating to AHI. I can't reveal it. I wouldn't reveal it. I will tell you that I don't believe it to be the entire story, and **I know of information that undermines or contradicts what they are saying publicly . There is, in my view, without a doubt, evidence of a cover up** . Now, some of that cover up is not necessarily that, oh, we found a weapon and we don't want anybody to know about it. What I've seen more so is we see lines of inquiry that would take us potentially to **answers we don't want to have to deal with** , so we're not going to explore any of those avenues.

- In 2024, 1 April, The Insider, 60 Minutes and Der Spiegel obtained a memo distributed to employees of the Tbilisi mission, that included several pages of guidance on how to talk to children about the strange events, offering distinct advice for different age groups. For young kids who “don't have enough life experience to understand some of the elements involved in complex, difficult topics like AHI,” **The implication here is that not only are AHIs real, but U.S. diplomats are all too aware of how they happen and who's behind them.**

From the same document: Mark Zaid: “I have spent more than a decade fighting for U.S. government employees and their families – sometimes small children and even pets – who have been victimized by AHIs overseas and domestically. It has been so distressing to see **how much effort our government has undertaken to cover up the true details of these attacks** , no doubt perpetrated by a foreign adversary.”

- In 2024, 4 April, on Fox News Jesse Watters. Jim Hanson, President of WorldStrat with Jesse Watters, at 3m30: **"These weapons exist, there is no question about that, we have them ..."**

- In 2024, 4 April, on NewsNation. Attacks with these weapons are known by the US government since the 1990's. Retired Army Lt. Col. Greg Edgreen, who led the Pentagon investigation on the Havana Syndrome, at 3m01: **"... it existed over several administrations ..."**

- In 2024, 4 April, Dr. James Giordano in National DEFENSE: **"... the individuals in Havana — and those subsequently verified — were exposed to some form of directable energy such as ultrasonic and or microwave ..."**

- In 2024, 5 April, in I-News. FBI agent: “The same tech that was used in Cuba was used against me and my wife,” he told i. “It was bizarre.” The agent described lying in bed while experiencing an external force on his skull and **intrusive thoughts**, which his wife corroborated ..."

- In 2024, 9 April, FBI Director Christopher Wray answering a Mark Zaid question: **"... I am firmly convinced and don't need any persuading, that the symptoms and experiences that both our employees and other employees of the U.S. government are experiencing are very real and very serious ... "**
- In 2024, 10 April, U.S. Sen. Ron Johnson said he experienced significant neurological symptoms consistent with Havana Syndrome following a 2018 trip to Moscow, which resulted in balance issues and permanent hearing loss in one ear.
- In 2024, 11 April, the House Homeland Security Subcommittee on Counterterrorism, Law Enforcement, and Intelligence Chairman August Pfluger (R-TX) announced a hearing entitled, " **Silent Weapons** : Examining Foreign Anomalous Health Incidents Targeting Americans in the Homeland", to receive testimony from experts and former government officials regarding anomalous health incidents (AHIs), also known as 'Havana Syndrome,' (or here) the symptoms of which have been reportedly experienced by an increasing number of Americans that have been **targeted abroad and in the homeland.** This hearing has been postponed until further notice. 16 April 2024
- In 2024, 18 April, U.S. Senator Ben Cardin (D-Md.), Chair of the Senate Foreign Relations Committee, Jeanne Shaheen (D-N.H.), a senior member of the U.S. Foreign Relations and Armed Services Committees, and Susan Collins (R-Maine), a senior member of the U.S. Senate Intelligence Committee, **sent a letter to President Joe Biden urging his administration to renew efforts to investigate the root cause behind anomalous health incidents (AHIs), also known as "Havana Syndrome."** They are joined by U.S. Senators Kirsten Gillibrand (D-N.Y.), Marco Rubio (R-Fla.), Mark Warner (D-Va.), Roger Wicker (R-Miss.), and Jim Risch (R-Idaho).

What we also know

- **The Havana Act is discriminatory: It excludes domestic cases, ignores a lot of symptoms, focusses only on visible brain damage, and excludes civilians.**
 You do not need to have visible brain damage, or other permanent damage, when you are attacked with pulsed radiofrequency (RF) energy. That is the 'beauty' of Directed Energy Weapons, most attacks leave no visible evidence and can easily be denied.
 Interviews with affected U.S. government employees, show that there are also a lot of domestic cases. Also FBI agents (Miami area) reported they are being targeted.
 And civilians have been reporting attacks with Directed Energy Weapons for over three decades. Some are attacked 24/7.
- **The Havana Syndrome is NOT caused by an unknown weapon.**
 1. Experts, including the National Academies of Sciences, Engineering, and Medicine and the US intelligence community Experts Panel concluded that the (most likely) cause is

'pulsed Radio Frequency energy,' in other words a Directed Energy Weapon.

2. The device can be portable, and even fit in a suitcase (James Benford).
3. The device can have moderate power requirements (Experts panel).
4. Experts, including the US intelligence community, and James Benford, acknowledge that microwaves propagate through building materials. Patent No. US 7.841,989 B2 (filed 2005), Non-lethal Electromagnetic Stand-off Weapon, describes a device that operates **through walls** and provides an individual soldier or law enforcement officer with the ability to reduce an opponent to helplessness from a remote location while doing no permanent damage.
5. Many people know what it is but cannot say it because this is classified information. Listen to Mark S. Zaid, lawyer, representing several Havana Syndrome diplomats: 'I have had access to classified information. And there is a lot of information that has not been publically revealed. And if you knew what it is, you would be very upset. I know that for a fact. Can't say what it is unfortunately. So it really sucks. I'm saying something I can't back it up.' Audio fragment (mp3) (from the Yahoo Conspiracyland podcast).
6. Mark S. Zaid: And the responses that came out, the answers were, oh, it's been going on for 15, 20 years. We knew it in the Executive Branch. We weren't telling our people that it was happening who were based there in Moscow.
7. Question by Nicky Woolf to Dr. James Giordano: 'Is there a type of microwave weapon out there that can cause this specific symptom profile that the victims in Havana experienced? That means something capable of not just causing the headaches, nausea, hearing and vision impairments, cognitive problems, even brain damage and all that - but also do it in this precisely targeted way?' Answer: 'Yes'.
8. Very short pulsed, delivery of this microwave energy, is used for example by militaries for RADAR (David A. Relman).
9. Nicky Woolf: ... the problem is that these type weapons we discovered do exist ... we know Lockheed Martin makes one, we know Raytheon makes one, we know there's a Chinese equivalent, we know there's a Russian equivalent, we know Australia has bought the Lockheed Martin one ...
10. Very short pulsed, delivery of this microwave energy, is used for example by militaries for RADAR (David A. Relman).
11. Jim Hanson President of WorldStrat, on Fox News Jesse Watters, at 3m30: "These weapons exist, there is no question about that, we have them ...".
12. (Through-wall) RADAR uses (pulsed) low duty-cycle, (very) high power microwaves.

- **How does it feel when you are attacked and there is no wound.**
 - Tina Onufer was attacked in March 2017, while serving as a foreign service officer in Cuba: There is nothing in the world that is worse than being a victim that everybody doubts.
 - Former CIA officer Marc Polymeropoulos, who was attacked in Moscow 2017, wished he had been shot with a gun, because then there was a wound, and nobody would dispute that.

- **And there is no protection, not even in your own home.**
 - '... And so effectively there is no way to protect either soldiers or diplomats from this type of weapons unless they are completely encased in metal?'. Professor Dr. Edl Schamiloglu of the University of New Mexico: 'Right'.
 - Experts, including the US intelligence community, and James Benford, acknowledge that microwaves propagate through building materials.
 - Patent No. US 7.841,989 B2 (filed 2005) describes such a weapon.

- **Also children (and pets) are attacked.**
 - CBS News did a separate report on the children of Havana Syndrome. Not only diplomats and CIA officers are attacked, their innocent children are also abused and tortured with these weapons. Many Targeted Individuals with children witness this themselves. Their children are attacked to give the parent(s) (maximum) pain. The parent(s) cannot protect their children, and the police cannot help. Unimaginable cruelty.
 - Catherine Werner, while serving in China: Her dogs were throwing up blood.

- **This has been going on for two, three decades.**
 - Mark Zaid: 'It started long before Havana. It was just those incidents that brought it to light.'
 - Mark Zaid: And the responses that came out, the answers were, oh, it's been going on for 15, 20 years. We knew it in the Executive Branch. We weren't telling our people that it was happening who were based there in Moscow.
 - Retired Army Lt. Col. Greg Edgreen, who led the Pentagon investigation on the Havana Syndrome, at 3m01: "... it existed over several administrations ...".

- **Victims, diplomats and security officers, receiving compensation from the US government.**
 - Bloomberg Law, 29 March 2023: State Department Will Pay \$460K to End Havana Syndrome Lawsuit
 - Mark Zaid, 28 March 2024: "... These diagnoses have enabled many victims to thankfully receive six-figure compensation payments from the U.S. Government for being an AHI victim. ..."
 - Nora Gámez Torres - Miami Herald, 29 March 2024: Despite clashes over reality of Havana Syndrome, CIA agents have been paid for injuries

- **The US military is developing a wearable 'RF weapon' exposure sensor.**
 - In 2019, 17 September, QinetiQ published a page on their website that the US military is developing a wearable 'RF weapon' exposure sensor. The mentioned requirements: "an extremely small footprint in terms of space, weight and power (SWaP), very low cost, very low false positive rate, and easy to interpret."
 - See also: Wearable Radio Frequency Weapon Exposure Detector.

"Directed energy weapons, including radio frequency (RF) weapons, are a growing threat on the battlefield. Determinants of RF weapon antipersonnel effects are multifactorial and RF injuries will be situation dependent and very hard to predict. "

- "Without known patterns of RF injury to guide diagnosis, **it will be difficult to differentiate RF injury from other common sources of illness and injury** such as heat stroke."
- "This ambiguous symptomology is aggravated by the transient nature of RF energy. **Without a sensor it is possible that no residual evidence of RF attack will be available.** "

So, here the US military says (their words, not mine) that when you are attacked with such weapons, it is at the moment (more or less) impossible to prove.

With this information, and all other information from the Havana Syndrome, GP's, psychiatrists, **MUST STOP** trying to label people mentally ill when they say they are attacked with these weapons, even if they act 'crazy' because of what happened to them, or what is being done to them.

- Phase II of the development of a Wearable Radio Frequency Weapon Exposure Detector was awarded to EngeniusMicro, also here with projects: ENGENIUSMICRO LLC.

- **The U.S. military confirms 1. the existence of these weapons, 2. people can be attacked with these weapons.**

On the official website of the Defense Health Agency (DHA), a component of the Military Health System, **they call it a counterintelligence incident** : Anomalous Health Incidents (a.k.a. Havana Syndrome) or here. Are you reading along, police, general practitioners and psychiatrists? It's not a mental problem! More than 1,000 U.S. diplomats and security personnel have reported these symptoms.

- **The Havana Syndrome is only part of the crimes, atrocities, that are committed against civilians with Directed Energy Weapons.**

Mind rape, (gruesome) torture, and non-consensual human experimentation like MK-ULTRA. For many civilians, the attacks are not a few times, but 24/7 for decades. The attacks start and never stop. A number of them claim that their children also are attacked. These crimes are among the worst in history and are a disgrace to humanity. Victims ask the police and their government for help. But so far they are not getting any help and the media is covering up their stories, or saying that these people are suffering from delusions or are mentally ill.

- **These crimes can no longer be denied.**

Unfortunately for the attackers, these crimes can no longer be denied, because Havana Syndrome gives us:

- Statements from credible medical doctors/specialists:
 - Michael Hoffer
 - Beatrice Alexandra Golomb
 - David A. Relman

- Statements from credible microwave experts:
 - James Benford
 - Edl Schamiloglu
 - James C. Lin
- Statements from credible neurotechnology experts:
 - James Giordano
- Statements from credible lawyers:
 - Mark Zaid
- Reports from credible organizations:
 - National Academies of Sciences, Engineering, and Medicine
 - Declassified Intelligence Community report of March 29, 2023
- Statements from credible victims: US and Canada diplomats and security personnel:
 - Marc Polymeropolous
 - Miles Taylor
 - Olivia Troy
 - ...
- Statements from credible people, politicians, who question the government narrative:
 - Marco Rubio

During the investigation into the Havana Syndrome, US diplomats and security (CIA) officers were asked to send reports if they believed they were attacked these ways. Over 1000 reports were received. The investigators only looked for visible brain damage, and excluded everything else.

- **1 March 2023 is Havana Syndrome Cover-up Day.**

The 1 March 2023 US Intelligence Community's Expert Panel Report 'Updated Assessment of Anomalous Health Incidents' and all the disinformation created around it, is a very important moment in history. Here the US government is trying to convince people that such weapons do not exist. What they say is: Nothing to see here, go back to sleep. It may take a year, it may take five or ten years, but then there will be irrefutable evidence that these weapons do exist and have been used for decades. And the people will understand that they have been lied to (again) on 1 March 2023. (The 29 March 2023 declassified copy of the Intelligence Community's Expert Panel Report appears to say the exact opposite of what the US government told everybody on 1 March 2023.)

- **The reason for the cover-up.**

After 1 March 2023 suddenly all the mainstream media went silent ... There is only reason for the silence: The Havana Syndrome has become a national security item. If the US would say that the Russians or Chinese have such weapons, then they would have to admit that they also have such weapons, which would spark a discussion about since when and how these weapons are used. ... officials would not discuss if the US has a weapon that could have caused these incidents

- **Ignore the Mass Psychogenic Illness theory.**

People like Robert E. Bartholomew blatantly ignore all scientific evidence. They appear to act as medical disinformation agents that try to prevent exposure of decades of lies and false diagnosis of innocent civilians.

Interviews with US Diplomats, CIA-officers, describing Havana Syndrome attacks and symptoms.

- US diplomats and security officers speaking in the 60 Minutes CBS News investigative report.



'Havana Syndrome' stumps investigators as U.S. officials report injuries on White House grounds (60 Minutes).

CBS News, 21 February 2022

- Olivia Troy was homeland security and counter-terrorism advisor to Vice President Mike Pence: 'It was like this piercing feeling on the side of my head ... it was on the right side of my head and I got like vertigo ... I felt unsteady, I was nauseous, I was somewhat disoriented'. The piercing feeling continued. This was followed by a paralyzing panic attack, which she never had. About a year it happened again a couple of times. 'It was a similar sensation but this time it was very much the feeling of vertigo and dizziness and I felt couldn't really walk. ... that I was just gonna fall right into the ground.'
- Another victim told Bolton he had disorientation and ringing in the ears and the inability to function. and that he couldn't speak or think clearly.
- Miles Taylor was deputy chief of staff and later chief of staff of the Trump administration Department of Homeland Security: He was hit with the same symptoms described by Olivia Troye. Five weeks later it happened again. The next day he was feeling off balance, out of it, the sort of concussion like symptoms you have from getting knocked very hard.

- Robyn Garfield, is a commerce department official: He, his wife and two children were repeatedly hit in China. His daughter was literally falling down multiple times a day. His family was hit again during their year of treatment in Philadelphia.

- US diplomats and security officers were not allowed to talk about their experiences. On October 2021 an exception was made for three / four diplomats who had been working in Havana. From the NBC News website:

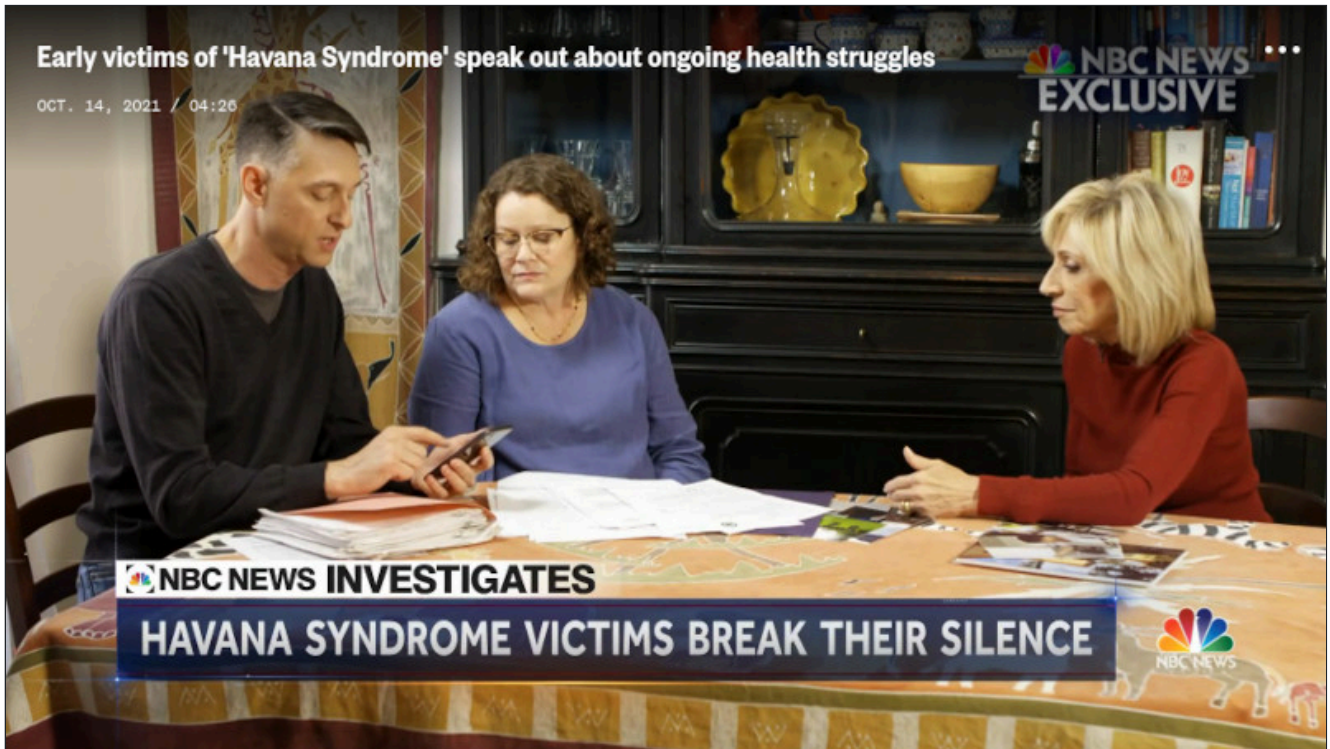

'Seized by some invisible hand': What it feels like to have Havana Syndrome

NBC News, 13 October 2021

'I felt like I was being struck with something,' she said. 'Pain that I have never felt before in my life ... mostly in my head and in my eyes.... It was as if I had been seized by some invisible hand and I couldn't move.'

Onufer and two of her former colleagues in Havana, a married couple named Kate Husband and Doug Ferguson, spoke to NBC News about their experiences after getting permission from the State Department. They want the world to know that what happened to them in Havana caused real suffering and documentable injuries, and that those who insist this must be a case of mass psychosis are wrong.



Legal, financial fights mount as 'Havana Syndrome' goes unsolved

NBC News, 22 December 2021

From the video on this page: Fighting an Invisible Enemy: The voices of Havana Syndrome.

- [07:25] There is nothing in the world that is worse than being a victim that everybody doubts.
- [09:40] The Havana Syndrome individuals had brain injuries that were very similar to a concussion.
- [10:10] This is not psychosomatic.
- [14:00] We looked at four possible mechanisms but came up with one we thought most possible and that was pulsed microwave energy.
- [14:20] The National Academy of Sciences report was really helpful and saying yes it is our belief that these are directed energy attacks.

- Catherine Werner, while serving in Guangzhou (China), started getting hives all over her body in October 2017, waking up with headaches every day, the simplest things made her feel very tired.



"60 Minutes" speaks with survivor of mysterious health attack in China

CBS News, 14 June 2021

- My symptoms would get so bad that I would throw up.
- She had not heard what happened in Cuba at the time this started.
- It was an intense pressure on both of my temples at the same time I heard of this low humming sound and it was oscillating.
- Her dogs were throwing up blood.
- Her mother experienced similar symptoms when she was visiting her in China.

- A senior official of the National Security Council (NSC), while walking to his car, between the White House and the Washington Monument, began to hear a ringing in his ears. His body went numb, and he had trouble controlling the movement of his legs and his fingers. Trying to speak to a passerby, he had difficulty forming words. "It came on very suddenly," the official recalled later, while describing the experience to a colleague. "In a matter of about seven minutes, I went from feeling completely fine to thinking, Oh, something's not right, to being very, very worried and actually **thinking I was going to die**."

- Mark Lenzi, his wife and children, were attacked in 2017 while he was working as a State Department security officer in the US consulate in Guangzhou, China. Symptoms were headaches, lightheadedness, nausea, nosebleeds, sleeplessness, and memory loss.



Mark Lenzi

CBS 60 Minutes, 31 March 2024

'This was a directed stand-off attack against my apartment. ... Of course it was a weapon. I believe it is RF, Radio Frequency, energy in the microwave range.

- Marc Polymeropoulos had a 26-year career with the CIA, when he was attacked in a hotel room in Moscow in December 2017.



Former CIA officer speaks out about "Havana Syndrome"

CBS News, 14 June 2021

'I woke up in the middle of the night and I had this incredible case of vertigo almost as if I was in some sort of carnival ride ... this was the most terrifying experience of my life, I had no control. I have had a headache for three years.'

- Karen Coates ([Karen Coats](#)) — who served as a human resources officer at the Havana embassy — told "Conspiracyland" that she was walking down a hallway in Havana when she was bowled over by loud, piercing sounds that resembled cicada chirping. "It was like a teapot on steroids," Coates said. "It, literally, it was so incapacitating that I ducked down with my head, my hands over my ears. ... All of a sudden I had this massive pressure in my face, where it felt like my face was literally gonna blow out." That night, Coates said, she became "very discombobulated" and "started having headaches. I couldn't walk." She was ultimately medevaced off the island and has spent years being evaluated and treated by government doctors — with no clear diagnosis — while suffering a significant cognitive decline. "I was a highly functioning individual," she said. "Now, like, I really have a hard time trying to talk and think."

[Top U.S. officials cast fresh doubt on sensational 'Havana syndrome' claims](#)

Yahoo News, 14 September 2022

- **Len Ber is medical doctor, a civilian, not related to the government, living near Chicago. His attacks started in 2019 and never stopped. He was diagnosed with the Havana Syndrome by Dr. Michael Hoffer, the same doctor that diagnosed many U.S. diplomats. So far, he is ignored by the mainstream media and government organizations.**



[Presentation "Havana Syndrome and My Personal Journey" at Total Information Control Conf. 12.02.2022](#)

Len Ber MD, 21 December 2022

List of Havana Syndrome symptoms

US government officials often relate the term Havana Syndrome to brain damage but there are much more effects. Below is a list of symptoms extracted from the documents about the Havana Syndrome on this page. For some, the symptoms went away quickly; for others, they persisted. (References to the symptoms are being added).

- Feeling as if standing in an invisible beam of energy
- Loss of balance and muscle control
- Brain fog
- Loss of hearing
- Incredible vertigo
- Thinking you are going to die (_)
- Wanting to throw up
- The room was spinning
- Vision problems, loss of vision
- Blacking out for no identifiable reason
- Fainting
- Overwhelming nausea
- (Massive) Nose bleed
- Ear pain
- Fatigue
- Retina bleeding
- Insomnia
- Sluggishness
- Nauseous
- Pressure in the head
- Ringing in the ears
- Buffeting of the head
- Pressure on the face/head without dizziness or nausea
- Pins and needles sensation
- A sound described as a buzz, clicking, hiss, or knocking within the head
- (Debilitating) Headaches
- Fatigue
- Dizziness
- Irritability
- Sleeplessness
- Depression
- Anxiety
- Forgetfulness
- Lack of concentration
- The sound came in a focused beam that they could step in and out of and the sound would start and stop. (_)

List of Havana Syndrome incidents by date and (geo)location (not complete!)

Country	Year	Month	City	Details	Symptoms
Cuba	2016	Dec.	Havana	Adam (pseudonym). Patient Zero. First case of Havana Syndrome	Balance problems, blind in one eye, loud noise, severe pressure in head, jabbing sensation in ear, loosing consciousness.
Cuba	2017		Havana	First cases of Havana Syndrome	
China	2017	Apr.	Guangzhou	Mark Lenzi, his wife and children	Headaches, lightheadedness, nausea, nosebleeds, sleeplessness, and memory loss
China	2017	Oct.	Guangzhou	Catherine Werner, her mother and dogs	Hives, vomitting, headaches, nosebleeds, loss of balance
Cuba	2017		Havana	Dr. Paul Andrews (pseudonym), CIA doctor	Sharp pain in ear, nausea, severe headache, clicking.
Uzbekistan	2017	Sept.	Tashkent	USAID officer and his wife	Acoustic attack similar to in Havana
Russia	2017	Dec.	Moscow	Marc Polymeropoulos	Incredible vertigo, dizziness, wanting to throw up, ringing in ears, headache for three years."
China	2018		Shanghai	Robyn Garfield, his wife and two children	Memory loss, strange noise, pulsating in his head, earache, shockwave through entire body paralyzing for four or five seconds, immense pressure in ears
USA	2018		Philadelphia	Robyn Garfield, his wife and two	Sound and pressure in head, children moving

Country	Year	Month	City	Details	Symptoms
				children, during treatment	in their sleep, bizarrely and in unison, vision and balance difficulties.
Russia	2018	Jul.	Moscow	Sen. Ron Johnson	<u>Significant neurological symptoms consistent with Havana Syndrome following a 2018 trip to Moscow, which resulted in balance issues and permanent hearing loss in one ear.</u>
USA	2018	Apr.	Washington(?)	Miles Taylor	Sort of chirping / digital sound, feeling sick, off balance, concussion like symptoms you have from getting knocked very hard.
Poland	2019	Spring		CIA officer	Diagnosed with occipital neuralgia, symptoms similar to Polymeropoulos.
Georgia	2019		Tbilisi	CIA officer (same as above)	Diagnosed with occipital neuralgia, symptoms similar to Polymeropoulos.
UK	2019	May	London	Several White House officials: Sandra Adams, Adrian Banks (pseudonyms)	Ringing sound, painful, pressure in head, migraines.
USA	2019	Summer	Washington	White House, Olivia Troye	Piercing feeling on the my head, vertigo, disoriented, paralyzing panic attack, dizziness
USA	2019	Nov.	Virginia	Sandra Adams (pseudonym)	High-pitched ringing in ears, intense headache,

Country	Year	Month	City	Details	Symptoms
					tingling on the side of face. Dog seizing up.
Australia	2019	Fall		Two CIA agents	Strange sound, pressure in head, ringing in ears, nauseous, dizzy.
Taiwan	2019	Summer		Two CIA agents (same as above)	Same as above.
USA	2019	Nov.	Washington	White House, person known by John Bolton (N.S.C. official?)	
USA	2020	Summer (?)	Washington	White House, Olivia Troye (it happened again)	
Kyrgyzstan	2020	?		U.S. military officer and his son	Intense pressure in the head, son screaming
Austria	2021	Aug.	Vienna	Two-dozen: diplomats, intelligence officials, and other government officials	Symptoms consistent with the Havana Syndrome
Vietnam	2021	Aug.	Hanoi	Two U.S. personnel were medevacked out of the country after Havana Syndrome incidents.	American personnel in Vietnam were informed the incidents involved strange sounds.
Germany	2021	Aug.	Berlin	Two US officials unable to work	Nausea, severe headaches, ear pain, fatigue and insomnia
India	2021	Sep.		CIA director's team member	

Country	Year	Month	City	Details	Symptoms
Colombia	2021	Oct.	Bogota	One American is affiliated with intelligence and one victim is a minor.	Havana Syndrome symptoms
France	2022	Jan.	Paris		
USA			Washington	White House. N.S.C. official	I was going to die, falling to the ground, like having a stroke.
Lithuania	2023	July	Vilnius	NATO summit, senior DOD official	Symptoms corresponding to Havana Syndrome.

Summary

There are people 'walking around' with EM-weapons (Electromagnetic weapons) attacking other people at least since the 1990s. Of course there is much more information on the internet about EM-weapons but I want to limit this to what has been published in the main stream media the last years.

Note: With 'walking around' I mean that you can be followed by DEW operatives with portable equipment, but you can also be attacked by equipment build into cars, 'surveillance' devices mounted in cities and shops, etc., and you can be attacked from the sky, like drones, aircraft, and perhaps even satellites.

Nobody can deny that there are people 'walking around' with these weapons and attacking other people, and that this has been going on for decades.

Timeline Russia - US relations

2008	Apr.	After the NATO Summit in Bucharest, NATO issued a statement that said Ukraine and Georgia would become part of NATO.
2014	Feb.	Ukraine (Euro)Maidan Revolution, seen by many as created by the U.S.
2014	17 Jul.	Malaysia Airlines Flight 17 (MH17/MAS17) was shot down flying over eastern Ukraine. All 283 passengers and 15 crew members were killed.

2015	Sep.	Direct military involvement of Russia in Syria. What happened here is that Russia started fighting the US in Syria.
2015	31 Oct.	Metrojet Flight 9268, operated by Russian airline Kogalymavia (branded as Metrojet), exploded above the northern Sinai Peninsula. All 217 passengers and 7 crew members were killed.
2016	Mar.	Barack Obama in Cuba
2016	9 Nov.	Donald Trump wins elections. Trump opposed good relations with Cuba.
2016	25 Nov.	Fidel Castro died
2016	Dec.	Start of Havana Syndrome incidents in Cuba
To be updated		

References:

- [A timeline of key events in the Trump-Ukraine story](#)
PBS News Hour - Magan Crane, 5 October 2019

Who is behind the attacks?

The following is pure speculation.

- Russia
 - Pros:
 - Did not want Cuba to have good relations with the US.
 - The US murdered Castro.
 -
 - Cons:
 -
 -
- US
 - Pros:
 - Deep state hated Trump.
 -
 -
 - Cons:
 - Why would they risk exposing this advanced technology?
 -
- (Western) New World Order
 - Pros:
 - Wanted to show Trump they can do what they want.

-
-
- Cons:
 -
 -

3. **New** Articles and videos - March, April 2024

From: UK tested sonic weapons that can replicate Havana syndrome

FBI agent claims to have been targeted by sonic weaponry

An FBI agent in charge of investigations against Russian espionage in the US has said they believed they experienced Havana syndrome in their home last year.

The law enforcement official, who i is not naming to protect their identity, claimed he believes he and his wife were targeted by sonic weaponry after they experienced severe intense pain in their heads at exactly the same time.

“The same tech that was used in Cuba was used against me and my wife,” he told i. “It was bizarre.”

The agent described lying in bed while experiencing an external force on his skull and intrusive thoughts, which his wife corroborated.

The FBI agent reported the incident to bosses at the agency but the incident was not escalated, as far as he is aware, he told i.

From: Havana Syndrome mystery continues as a lead military investigator says bar for proof was set impossibly high (transcript)

One of them is Carrie. We're disguising her and not using her last name because she's still an FBI agent working in counterintelligence. She says, in 2021, she was home in Florida when she was hit by a crippling force.

Carrie: And bam, inside my right ear, it was like a dentist drilling on steroids. That feeling when it gets too close to your eardrum? It's like that, you know, times ten. It was like a high pitched, metallic drilling noise, and it knocked me forward at, like, a 45 degree angle this way.

She says she was by a window in her laundry room.

Carrie: My right ear was line-of-sight to that window while this thing was happening in my ear. And when I leaned forward it kind a—it didn't knock me over, but it knocked me forward. I immediately felt pressure, and pressure and pain started coursing from inside my right ear, down my jaw, down my neck and into my chest.

At the same time, FBI agent Carrie told us, the battery in her phone began to swell until it broke the case. Finally she passed out on a couch. Because of chest pain, she was checked by a cardiologist and then returned to duty.

...

Scott Pelley: What do you make of the intelligence community assessment?

Mark Zaid: So I've had access to classified information relating to AHI. I can't reveal it. I wouldn't reveal it. I will tell you that I don't believe it to be the entire story, and I know of information that undermines or contradicts what they are saying publicly.

Scott Pelley: Are you saying that the government wants to cover this up?

Mark Zaid: There is, in my view, without a doubt, evidence of a cover up. Now, some of that cover up is not necessarily that, oh, we found a weapon and we don't want anybody to know about it. What I've seen more so is we see lines of inquiry that would take us potentially to answers we don't want to have to deal with, so we're not going to explore any of those avenues.

From: [Unraveling Havana Syndrome: New evidence links the GRU's assassination Unit 29155 to mysterious attacks on U.S. officials and their families](#)

The State Department has walked a knife-edge in addressing that contingency. The Insider, 60 Minutes and Der Spiegel obtained a memo distributed to employees of the Tbilisi mission on December 29, 2021 — over two months after Joy's attack. It references a task force responsible for coordinating response to AHIs and several pages of guidance on how to talk to children about the strange events, offering distinct advice for different age groups. For young kids who "don't have enough life experience to understand some of the elements involved in complex, difficult topics like AHI," the memo advises parents to catch their biases and limit the amount of information their children can access: "Don't say things like 'the Russians are trying to hurt or intimidate us' or 'if you hear a loud noise, you are probably going to feel dizzy and sick so make sure you get off the X, etc.'"

The implication here is that not only are AHIs real, but U.S. diplomats are all too aware of how they happen and who's behind them.

Still, it remains unclear why it took American officials so long to acknowledge the problem, and why they still show no sign of having a plan to solve it. "I have spent more than a decade fighting for U.S. government employees and their families — sometimes small children and even pets — who have been victimized by AHIs overseas and domestically," says attorney Mark Zaid. "It has been so distressing to see how much effort our government has undertaken to cover up the true details of these attacks, no doubt perpetrated by a foreign adversary."

References:

1. [Implementation of HAVANA Act of 2021](#)
[A Rule by the Justice Department on 04/19/2024](#)
Federal Register, 19 April 2024
2. [Justice Department outlines benefits rule for Havana syndrome victims](#)
Carten Cordell - Government Executive, 19 April 2024
3. [Senators call for renewed Havana Syndrome assessment after 60 Minutes report](#)
Aliza Chasan, Michael Rey, Oriana Zill de Granados - CBS News, 17 April 2024
4. [CIA to Workforce: Drop Dead](#)
John Schindler - TOP SECRET UMBRA, 16 April 2024

5. [CIA doubles down on see-no-Russian Havana syndrome spin](#)
Tom Rogan - Washington Examiner, 16 April 2024
6. [Risch Joins Shaheen, Collins, Colleagues in Letter Urging the Biden Administration to Renew Efforts to Identify the Cause of Anomalous Health Incidents](#)
Foreign Relations Committee, 15 April 2024
7. [Subcommittee Hearing to Examine Homeland Security Threats Posed by Havana Syndrome This hearing has been postponed until further notice. 16 April 2024](#)
House Homeland Security Subcommittee on Counterterrorism, Law Enforcement, and Intelligence Chairman August Pfluger (R-TX), 11 April 2024
8. [Alleged CIA developed Havana Syndrome energy-weapon, attorney says one possible theory for coverup](#)
Steve Schuster - Wisconsin Law Journal, 10 April 2024
9. [FBI Head: 'Havana Syndrome' Is 'Very Real And Very Serious', Foreign Involvement Remains Unclear](#)
Forbes Breaking News, 9 April 2024
10. [Shaheen Questions Secretary Austin on Havana Syndrome Investigation](#)
Senator Jeanne Shaheen, 9 April 2024
11. [UK tested sonic weapons that can replicate Havana syndrome](#)
Richard Holmes - I News, 5 April 2024
12. [VIEWPOINT: Directed Energy Remains Key Suspect Behind Havana Syndrome](#)
Dr. James Giordano, 4 April 2024
13. [Attacks with these weapons are known by the US government since the 1990's. Retired Army Lt. Col. Greg Edgreen: ... it existed over several administrations ...](#)
NewsNation, 4 April 2024
14. [Jim Hanson, President of WorldStrat, at 3m30:](#)
["These weapons exist, there is no question about that, we have them ..."](#)
Jesse Watters - Fox News, 4 April 2024
15. [US defense official had 'Havana syndrome' symptoms during a 2023 NATO summit, the Pentagon confirms](#)
Tara Copp - The Associated Press, 1 April 2024
16. [Havana syndrome: Report links mystery illness to Russian intelligence unit](#)
James FitzGerald - BBC News, 1 April 2024
17. [Setzten russische Agenten Mikrowellenwaffen gegen US-Diplomaten ein?](#)
Der Spiegel, 1 April 2024
18. [Unraveling Havana Syndrome: New evidence links the GRU's assassination Unit 29155 to mysterious attacks on U.S. officials and their families,](#)
The Insider, 1 April 2024
19. [On retiring from the US Army, Greg Edgreen founded "Advanced Echelon" to help #HavanaSyndrome \(aka AHI\) victims.](#)
Microwave News, 1 April 2024
[Advanced Echelon is the only company in the US with interagency experience taking care of Anomalous Health Incident\(AHI\)/Havana Syndrome survivors.](#)
Advanced Echelon, 19 March 2024

20. Russian military intelligence unit may be linked to 'Havana syndrome', Insider reports, Reuters, 1 April 2024
21. Havana Syndrome evidence suggests who may be responsible for mysterious brain injuries, and, Havana Syndrome mystery continues as a lead military investigator says bar for proof was set impossibly high (transcript)
Scott Pelly - CBS News, 31 March 2024
22. 5-year Havana Syndrome investigation finds new evidence of who might be responsible
Will Croxton - CBS News (60 Minutes), 31 March 2024
23. Despite clashes over reality of Havana Syndrome, CIA agents have been paid for injuries
Nora Gámez Torres - Miami Herald, 29 March 2024
24. Havana syndrome mystery deepens as landmark study looks at brain injuries in patients
Lauran Neergaard - Independent, 19 March 2024
25. New NIH study sheds light on mysterious 'Havana Syndrome': Victims' symptoms are 'real' and 'quite profound' - but injuries don't show up on MRI much like a 'mini stroke,' one Pentagon medical consultant tells DailyMail.com
Matthew Phelan - Mail Online, 18 March 2024
26. Mystery illness among U.S. diplomats did not cause permanent brain damage
Richard Stone - Science.org, 18 March 2024
27. As the Havana Syndrome scandal rumbles on, Nikolai Patrushev must be laughing
Tom Rogan - Washington Examiner, 19 March 2024
28. U.S. 'Havana syndrome' reports raise concerns, Canadian diplomats' lawyer says
Nathaniel Dove - Global News, 19 March 2024
29. I represent more than two dozen AHI victims from CIA, NSA, DIA, State, Commerce, USAID and FBI. Our response to the @NIH studies published by @JAMA_ current is below.

STATEMENT OF MARK S. ZAID, ESQ

Today's publication by the Journal of the American Medical Association of two articles on studies conducted by the National Institutes of Health regarding Anomalous Health Incidents ("AHI") offers very little new substantive results. After comparing several dozen AHI victims, many of whom are my clients, to non-AHI controls between 2017-2021, NIH could not identify any significant medical differences between the two populations after time had passed. Of course, the absence of evidence is not evidence and these studies therefore do nothing to undermine the theory that a foreign adversary is harming US personnel and their families with a form of directed energy.

The problem, however, is that the absence of conclusive proof is disingenuously relied upon by the Intelligence Community and naysayers to support their public assertion that AHI does not exist. The government is knowingly weaponizing the lack of science that exists in this area and intentionally hiding behind a classification wall where much of the evidence that contradicts the results exists.

That said, the studies themselves are rife with substantive and ethical concerns. The victims were almost always examined long after their injuries occurred (knowing many of the tell-tale markers would have dissipated earlier) and NIH did not have pre-event data to compare for each individual.

Indeed, I made it known to JAMA and NIH a week before publication that ethical concerns existed regarding the participation of some of the test subjects. Several of my clients were told they had to participate in the study if they wanted to receive medical treatment for their injuries, a significant faux-pas in a medical arena that promotes informed consent. Although I offered to provide evidence and make my clients available for questioning, neither organization inquired further. Instead, NIH held a secret press conference days later to help defend its findings.

Perhaps of greater concern is the fact one of the NIH studies' authors is a senior medical official at the Department of Defense's National Intrepid Center of Excellence ("NICoE") and has been personally involved in overseeing the diagnosis of AHI victims as having traumatic brain injuries (TBI). These diagnoses have enabled many victims to thankfully receive six-figure compensation payments from the U.S. Government for being an AHI victim.

The question must be asked: how can these facts be reconciled with these study conclusions that effectively say "nothing there"?

The USG must declassify what it knows about AHI to ensure accountability and truthfulness.

Mark S. Zaid, 18 March 2024

30. David Relman, MD: "The experience with AHIs provides valuable lessons for clinicians, the scientific and national security communities, and national and international policymakers. We ignore them at our own, collective peril." ja.ma/3TkinAl
JAMA @JAMA_current, 18 March 2024
31. Neurological Illness and National Security Lessons to Be Learned
David A. Relman, MD, 18 March 2024
32. In study that included 86 participants reporting anomalous health incidents & 30 matched control participants, there were no significant differences in most tests of auditory.

vestibular, cognitive, visual function, or blood biomarkers between the groups.

<https://ja.ma/3IFRL7V>

JAMA @JAMA_current, 18 March 2024

33. Clinical, Biomarker, and Research Tests Among US Government Personnel and Their Family Members Involved in Anomalous Health Incidents

Leighton Chan, MD, MPH^{1,2}; Mark Hallett, MD³; Chris K. Zalewski, PhD⁴; et al, 18 March 2024

34. Breaking news: Repeated scans of patients suffering from the mysterious ailment commonly known as “Havana syndrome” found no significant evidence of brain injury, according to an ongoing investigation by the National Institutes of Health.

The Washington Post @washingtonpost, 18 March 2024

35. Out today: Two new papers from @NIH on #HavanaSyndrome + editorial by David Relman @Stanford. All appear in @JAMA_current & are open access.

NIH found “no significant” evidence of brain injury or biological abnormalities among those reporting symptoms.

<https://nih.gov/news-events/news-releases/nih-studies-find-severe-symptoms-havana-syndrome-no-evidence-mri-detectable-brain-injury-or-biological-abnormalities>

1/2

In sharply worded critique Relman shows he’s far from convinced that @NIH studies are the end of the #HavanaSyndrome story.

He decries lack of detailed info on bioeffects of EM & acoustic energy on the brain despite >60 yrs of interest.

Some excerpts 📌

<https://jamanetwork.com/journals/jama/fullarticle/2816534>

2/2

...[Another] issue that has undermined efforts to explain [anomalous health incidents] is the relative lack of detailed information about the biological effects of electromagnetic and acoustic energy on the brain, despite more than 60 years of interest in this topic, non-Western work and non-English-language literature on this subject, and emerging therapeutic use of electromagnetic and acoustic energy for psychiatric and neurological disorders...

Emerging experience with the clinical use of pulsed electromagnetic fields also lended support to arguments for plausibility. Yet, a paucity of mechanistic studies has led to controversy and lingering uncertainty about the possible relationship of pulsed radiofrequency and ultrasound to AHIs. Given the circumstances, a coordinated national research effort that examines the cellular, tissue, and clinical effects of focused, pulsed forms of electromagnetic and acoustic energy is warranted...

A lack of information about the effects of radiofrequency energy was interpreted as evidence of implausibility, some cases were ignored or inadequately treated, and the response became part of the problem. The unfortunate tendency to dismiss disorders such as chronic fatigue syndrome and long COVID as of psychological origin illustrate this difficulty.

Microwave News @MicrowaveNews, 18 March 2024

36. NIH studies find severe symptoms of "Havana Syndrome," but no evidence of MRI-detectable brain injury or biological abnormalities
National Institutes of Health (NIH), 18 March 2024
37. A 'Havana Syndrome' Investigation in Congress Rests on Politics, Not Science
Robert Bartholomew - Scientific American, 15 March 2024
38. Foreign governments "by chance" found Trump advisors colluding with Russians, the CIA said. But they didn't. The CIA asked them to spy, illegally. And now, the chairmen of the House Intelligence and Judiciary committees have demanded that the CIA give up the secret documents
Michael Shellenberger, 11 March 2024

4. **New** Articles and videos - January, February 2024

From [7]: Court document

... The Industrial Microwave System can be used, with minor modifications, for military uses, including as a high-power microwave based directed-energy weapons system capable of targeting personnel, missiles, vehicles, and optical devices with highly energy.

...

The Purchase and Sale Agreement was signed by ..., and was in the amount of \$450,000 USD.

From [6]: NATIONAL DEFENSE AUTHORIZATION ACT FOR FISCAL YEAR 2024

SEC. 917. MODIFICATION OF CROSS-FUNCTIONAL TEAM TO ADDRESS EMERGING THREAT RELATING TO ANOMALOUS HEALTH INCIDENTS.

- (1) to investigate and carry out such other activities as may be necessary
 - (A) to identify anomalous health incidents;
 - (B) to determine the causes and sources of such incidents, including identification of any individuals, entities, capabilities, or phenomena to which such incidents may plausibly be attributed; and
 - (C) to understand how such incidents may be mitigated and treated;
- (2) to address the challenges posed by anomalous health incidents, including by coordinating research into
 - (A) non-kinetic capabilities that plausibly might result in such incidents, such as anti-personnel capabilities and directed energy capabilities;
 - (B) the detection and mitigation of such capabilities; and
 - (C) the development of countermeasures for such capabilities;
- (3) to integrate and deconflict the efforts of the Department of Defense regarding anomalous health incidents with the efforts of other departments or agencies of the Federal Government regarding such incidents; and
- (4) to undertake any other efforts regarding non-kinetic threats to personnel and anomalous health incidents that the Secretary considers appropriate.

- (4) in subsection (e)(2)—13
 - (A) by striking “March 1, 2026” and inserting “March 1, 2028”; and
 - (B) by striking “with respect to the efforts of the Department regarding anomalous health incidents” an inserting “on any activities carried out to fulfill the duties specified in subsection (b) since the date of the preceding briefing under this section”.

References:

1. FBI started spying on the Trump campaign after foreign governments "by chance" discovered evidence that his advisors were colluding with the Russians, the government says. But now, multiple credible sources tell us that the CIA asked foreign allies to spy on 26 Trump associates.
Michael Shellenberger, 13 February 2024
2. CIA Had Foreign Allies Spy On Trump Team, Triggering Russia Collusion Hoax, Sources Say. United States Intelligence Community targeted 26 Trump advisors for foreign spy agencies to “reverse target” and “bump”
Michael Shellenberger, 13 February 2024
3. Congress to Examine U.S. Spy Agencies’ Work on Havana Syndrome
The New York Times - Julian E. Barnes, 12 February 2024
4. Bonus-wag: PAUL'S "HAVANA" SYNDROME STORY
Paul Giamatti, 9 February 2024
5. Wenstrup Introduces ‘Havana Syndrome’ Health Bill
The Scioto Post - Jeremy Newman, 7 February 2024
6. ANNUAL THREAT ASSESSMENT OF THE U.S. INTELLIGENCE COMMUNITY
Office of the Director of National Intelligence, 5 February 2024
7. NATIONAL DEFENSE AUTHORIZATION ACT FOR FISCAL YEAR 2024
December 2023
8. Courtcase
Case: 1:19-cr-00073
Assigned To: Judge Friedrich, Dabney L.

5. **New** Articles and videos - November, December 2023

From [2] Rubio, Warner Praise Passage of Intel Authorization Act:

- Ensures continued support to the victims of anomalous health incidents (AHIs or “Havana Syndrome”) by improving the CIA’s funding flexibility for payments to qualified victims
- Requires each IC element to issue regulations and procedures for implementing HAVANA Act of 2021 authorities.

From [6] The Sound: Mystery of the Havana Syndrome — A Conversation with Nicky Woolf:

There is only a very short episode about civilians:

[55m10] ... reported instances everywhere but these go these run the gamut for some senior

State Department um employees to some dude in Iowa who thinks the government has beaming and a lot of people it turns out think the fovernment is using microwaves to beam messages into their brains

Vivien Schmidt: question is what kind of messages

and actually even more than that, a lot of people think their neighbors are using microwaves that be messages into their brains, there's a lot of accusations of what's the word just being messed with rather than being some kind of statecraft we didn't give that a huge amount of credit because that that way madness lies but ...

References:

1. Mislabeled as a threat
How the Terrorist Watchlist & Government Screening Practices Impact Americans
United States Senate Committee on Homeland Security & Governmental Affairs, December 2023
2. Rubio, Warner Praise Passage of Intel Authorization Act
Marco Rubio, 14 December 2023
3. A Series Of Unfortunate Events Haunt Swiss Embassy In Tehran
Iran International, 7 December 2023
4. 1/We have filed another #FOIA lawsuit for @JMadisonProject /@BrianKarem seeking disclosure of records concerning Anomalous Health Incidents (#AHI) Specifically, an "Urgent Concern" #whistleblower complaint & accompanying exhibits w/i @ODNIgov Inspector General files.
Mark S. Zaid - Twitter, 21 November 2023
5. Army Ends Brain-Damage Test on Ferrets at Wayne State After PETA Outcry
PETA, 16 November 2023
6. A Regulatory Pathway Model of Havana Syndrome Neuropsychological Disruption
Physician's Weekly, 14 November 2023
7. Interestingly, Woolf believes that the DNI (probably at the request of the CIA) deceived the Washington Post when when several high ranking officers told Shane Harris that there was nothing to the story...
Intel Today, 15 November 2023
8. The Sound: Mystery of the Havana Syndrome — A Conversation with Nicky Woolf
Talk with Vivien Schmidt, Professor of International Relations and Political Science, 4 November 2023
9. Canadian diplomats court case T-238-19
Update, 10 November 2023

6. Articles and videos - September, October 2023

References:

1. [A regulatory pathway model of neuropsychological disruption in Havana syndrome](#)
Thomas P Chacko, J Tory Toole, Matthew C Morris et al., 27 October 2023
2. [Havana Syndrome hits CIA, Congress in Wisconsin, Russia takes credit](#)
Steve Schuster - Wisconsin Law Journal, 27 September 2023

7. Articles and videos - July, August 2023

References:

1. [Was Havana syndrome caused by an energy weapon?](#)
Steve Schuster - Wisconsin Law Journal , 16 August 2023
2. [Havana Syndrome — The Missing Piece of the Puzzle](#)
Intel Today, 16 August 2023
3. [Havana syndrome FOIA: MANHATTAN — A federal court in New York denied the New York Times and the FBI's competing motions for summary judgment in the paper's request for a copy of an FBI Behavior Analysis Unit report on the "Havana syndrome" phenomenon. The FBI hasn't shown why it shouldn't be disclosed, but in camera review must first be conducted prior to release.](#)
Ruling
Courthouse News Service, 10 August 2023
4. [Centre to look into Havana Syndrome in India: What is this mysterious illness?](#)
India Today, 8 August 2023
5. [A good day in our #AHI #FOIA case against #CIA. In a #NationalSecurity case, I'll take this outcome any day. Whenever we delay the govt winning, that's a win!](#)
Mark S. Zaid, 1 August 2023

8. Articles and videos - May, June 2023

References:

1. [I believe injured diplomats from U.S. and Canada, not the intel report. Havana Syndrome was real | Opinion](#)
Miami Herald - Fabiola Santiago, 4 May 2023
2. [Havana Syndrome upsets so many Americans because of the secrecy involved](#)
The Washington Post - Nicole Bauer, 4 May 2023

9. **New** Declassified report suggests "Havana syndrome" could result from energy weapon - 29 March 2023

From the declassified report:

Electromagnetic energy, especially pulsed signals in the radio frequency range, plausibly explains the main features, although there are gaps in information. There are several plausible paths associated with forms of electromagnetic energy, each with its own requirements, limitations and unknowns. For all pathways, there are sources that can generate the required stimuli, are latent, and require moderate power.

From [1]:

The document was released pursuant to the following FOIA exemptions: "(...) — (b)(3), which applies to information exempt from disclosure by statute, and, in this case, specifically the National Security Act of 1947, as amended, statutes 50 U.S.C. § 3024(i) and 50 U.S.C. § 3024(m), which protect intelligence sources and methods and identifying information of ODNI personnel, respectively; (..)”. This means more important information may have been removed from this report and still remains classified.

References:

1. Random Thoughts — Reading Behind the Black Bars : ODNI Redacted Summary on Havana Syndrome [UPDATE : Full IC EXPERTS PANEL ASSESSMENT released under FOIA]
Intel Today, 31 March 2023
2. Newly Declassified Report on 'Havana Syndrome' Used the Wrong Criteria!
Robert E. Bartholomew, 31 March 2023
3. I hope journalists interested in Havana Syndrome (and the very confusing govt flip flops) dive into the just declassified 150 plus page DNI Experts Panel report. Thanks to @MarkSZaidEsq and @BradMossEsq for their tireless work on this.
<https://media.salon.com/pdf/22-cv-674%20Final%20Response%20Package.pdf>
Marc Polymeropoulos, 31 March 2023
4. Newly Declassified Report Contradicts Officials, Suggests Havana Syndrome Might Be Caused by Directed Energy.
Yahoo News (Gizmodo), 30 March 2023
5. Readily available energy technology could be behind Havana Syndrome, declassified report says
Miami Herald, 30 March 2023
6. Pulsed RF: Plausible Cause of Havana Syndrome
Microwave News, 30 March 2023
7. Exclusive: Declassified report suggests "Havana syndrome" could result from energy weapon
MSN.com, 30 March 2023
8. 'Havana syndrome' could be the result of electromagnetic weapon: declassified report
Yahoo News, 30 March 2023
9. 'Havana syndrome' could be the result of electromagnetic weapon: declassified report
The Hill, 30 March 2023
10. FOIA litigation @MarkSZaidEsq and I led brought about the release of this report. Exclusive: Declassified report suggests "Havana syndrome" could result from energy

weapon | <http://Salon.com>

Bradley P. Moss, 30 March 2023

11. My law firm successfully obtained through #FOIA litigation a declassified copy of Intelligence Community's Expert Panel Report on Anomalous Health Incidents (#AHI). No way this can be reconciled w/recent IC Assessment conclusions. AHIs are real & caused by human actors.

Mark S. Zaid, 30 March 2023

12. Declassified: Anomalous Health Incidents: Analysis of Potential Causal Mechanisms
IC Experts Panel Assessment, September 2022

13. Declassified report suggests "Havana syndrome" could result from energy weapon
Salon.com, 29 March 2023

10. **New Articles and videos - March, April 2023**

From [5] 'Bret Baier presents report on Havana Syndrome statistics contradicting government response':

IC report: 'There is no credible evidence that a foreign adversary has a weapon or collection device that is causing AHIs [Anomalous Health Incidents]'.

James Benford: 'It is false, that statement is false, ... and verifiable false. That sentence is definitively disinformation ... it looks like a cover-up.'

Edl Schamiloglu, University of New Mexico, sides with James Benford.

Adam (Patient Zero): The latest ones I have heard about been DoD cases and those were towards the end of last year.

From [7] "'Havana Syndrome" – A Panel featuring Nicky Woolf, Marc Polymeropoulos, and Mark Zaid':

Mark Zaid: So that's where we're kind of looking at the technology, from the government standpoint, the legislative standpoint. How long has the Executive Branch known this was happening? To what extent were they telling anyone it was happening, a la what Kissinger was referencing? And what were the long-term health effects of it happening? And the responses that came out, the answers were, oh, it's been going on for 15, 20 years. We knew it in the Executive Branch. We weren't telling our people that it was happening who were based there in Moscow. And we have no idea of the long-term health impact because not enough time has gone by in 1977 or '9, whenever the -- the hearing was, because it had only been a few years that some of these people had been impacted. And why is it that that's not being studied? Why is it there's no report on that?

From [11] 'EXCLUSIVA: Ex alto oficial de la CIA: Rusia y Cuba están detrás del Síndrome de La Habana':

Marc Polymeropoulos: And looking back just knowing the cases in Havana as well, what was interesting about Havana is, it was happening to different US officials there but they weren't

telling each other about it. So there is no mass psychosis there as well. ...

[19:20] Here is what I think. Obviously there is technology, this directed energy technology, that can be used for signals intelligence collection, exactly what you are saying, collect info from your cell phone, maybe they are trying to listen into discussions in a room for example.

It is possible that is how this started but I think, is what the Cubans and the Russians eventually learned is, that it also could be used as a weapon. So perhaps it evolved. Perhaps in Havana for example, when they did this the first couple of times, they were trying to collect information, cell phone discussions, you know, verbal discussions, but then they see it injures some US officials and they say, Well wait a second, maybe we can use this as a weapon, and why was this a, and I hate to say this because it happened to me, why this is a brilliant weapon is, it is what we call 'not attributable', nobody can find out about it, it's hard to detect, and what it does is, it is not shooting someone with a pistol, it's a salting mem on a street, what it does is, they're removing American Intelligence officers from the battlefield, which is exactly what the Cuban intelligence service wanted, do you think they wanted American intelligence officers in Havana? Exactly what the Russians want

So it's taking them off the battlefield in a manner, which is hard to detect. It actually is a perfect weapon, if you think about it that way. And so that's my sense, it started off as a signals collection tool they saw what it was doing to people and then they weaponized it. And that is my theory and I have no evidence on this other than that it makes a lot of sense.

And then I throw in the last piece and that is the idea that this technology does not exist, is ridiculous. The US government by the way has this, the Russian government has this, if you look in the open-source world, there is Directed Energy Weapons that people use for riot control for example. And the Department of Defense, we've been testing this stuff and when you look at the open source on the internet, the Russians have been too, so this technology exists. This is not some kind super secret James Bond type ... The reason is why it has never been used on people is because it is unethical, it's immoral, look what's happening to us, so there is an ethical reason not to do it,

...

[24:10] If you look right behind me there is a picture on my wall. It was painted by one of the victims. It's a black canvas with a red splash of paint. And we call that the gunshot. And that is notion that we always wished we had been shot because then people would have believed us, you have a bullet wound. Now in some essence, in some sense, we do have that with some of the doctors and some of the doctors reports but I tell you a lot of more people would have believed us and we would have gotten medical treatment right away if there was a gunshot, if there was a wound. I could say look I am shot, I'm bleeding, I need care, no one would dispute that. And that's so we say that all the time and still to this day, feel that way because, you know when you have a brain injury, you know what does that mean, it means it's silent, nobody can

see it, you know there is day I am feeling ok today and I'm feeling much better. Some days you have a terrible headache, some days you have brainfog, you forget things a bit.

...

From [15] 'The Sound, Chapter 8: Hammers and Nails':

Kenneth Jones (Ken Jones), worked for the FBI from 1989 to 2017. In 2009, Ken was posted to an embassy overseas. He won't say where. Ken: Yeah, the, the language, business language is Russian. ... yeah, I would just say it's a former Soviet country ... One day, when he gets to work

...

In 2009, Ken was posted to an embassy overseas. He won't say where. Ken: Yeah, the, the language, business language is Russian. ... yeah, I would just say it's a former Soviet country ... One day, when he gets to work...

As we've seen, embassies have different agencies represented within them, operating under diplomatic cover. CIA. NSA. And others.

Ken: I really ... didn't think... at that time, in the end of 2011, to say, like, 'Hey, are they still out there attacking that with radio frequencies?'

Ken: ... but I can tell you shortly after that, I started experiencing daily migraines...

Ken: It felt like... if, if someone was gonna stick a spike or a nail or something right through the side of my temple ... That was the most intense pain or pressure I've ever felt... The symptoms worsen. He's dizzy, fatigued and nauseous. Ringing in his ears. Doctors can't figure out what's going on.

Ken: And I started thinking, I'm losing my mind. I'm getting ... I just started crying. I'm like, this is insane ... For years he doesn't link the symptoms to the radiofrequency attack. He'd been briefed on security threats before the posting, but they never mentioned anything like this. He'd never heard of RF exposure or its potential effects. It's only years later, when he hears about Havana Syndrome on the news, that he makes the connection.

Ken is the first, and so far the only, FBI agent to tell his story on the record. But he tells us others have come forward internally. This radio wave attack – the one an intel agency told Ken was happening – was in 2011. Way before the Havana outbreak.

Kevin and Karen Coats – the sound came in a focused beam that they could step in and out of and the sound would start and stop.

Mitchell: ... it was, uh, President Trump's intention to roll back everything that Obama had achieved in bringing the two countries closer together.

Marc: There seems also to be a difference between what was briefed at the DNI and actually what's in the content of the, the actual assessment. ... Whereas what I've been told is that DOD is not on board with this.

Nicky Woolf: ... There are thousands of claimed cases worldwide. It's just common sense that the vast majority of them are unlikely to be attacks with weapons. Right? I mean, I really hope that's true.

References:

1. ['Havana Syndrome' is just a new name for Cuba's bad old habit of attacking diplomats | Opinion](#)
Yahoo News, 29 April 2023
2. [JOHN KIRIAKOU: Havana Syndrome — Paranoia or Reality?](#)
Consortium News, 29 April 2023
3. ['Knife in the back': Havana Syndrome victims dispute report dismissing their cases](#)
Miami Herald, 26 April 2023
4. [Pentagon Requests \\$36 Million for Havana Syndrome](#)
The Intercept, 20 April 2023
5. [Bret Baier presents report on Havana Syndrome statistics contradicting government response](#)
Fox News, 18 April 2023
6. [Havana syndrome: Foreign adversaries' microwave weapons capabilities explained by physicist](#)
Fox News, 18 April 2023
7. ["Havana Syndrome" – A Panel featuring Nicky Woolf, Marc Polymeropoulos, and Mark Zaid](#)
SpyCast, 11 April 2023
8. [State Department Will Pay \\$460K to End Havana Syndrome Lawsuit](#)
Bloomberg Law, 29 March 2023
9. [Evaluation of the DoD's Management of Traumatic Brain Injury \(DODIG-2023-059\)](#)
Department of Defense Office of Inspector General, 28 March 2023
10. [State Dept., Employee Settle Havana Syndrome Disability Suit](#)
Bloomberg Law, 22 March 2023
11. [EXCLUSIVA: Ex alto oficial de la CIA: Rusia y Cuba están detrás del Síndrome de La Habana](#)
Americateve, 19 March 2023
12. [Havana Syndrome Revisited](#)
Wall Street Journal, 19 March 2023
13. [What We Can Learn From the 'Havana Syndrome' Fiasco](#)
Psychology Today, 16 March 2023
14. [Havana syndrome: Spooky sounds](#)
Quartz, 16 March 2023
15. [The Sound, Chapter 8: Hammers and Nails \(transcript\)](#)
Project Brazen & PRX, 13 March 2023
16. [EXCLUSIVE: Scientist who investigated Havana Syndrome insists US enemies ARE to blame for mysterious condition afflicting 1,500 embassy staff worldwide - and slams government report for denying it](#)
Mail Online, 13 March 2023
17. [John Bolton chose not to brief Trump on Russia Havana syndrome suspicion](#)
The Guardian, 13 March 2023
18. [Evaluation of the DoD's Response to Anomalous Health Incidents, or "Havana Syndrome" \(DODIG-2023-054\)](#)
Department of Defense, 13 March 2023

19. VIEWPOINT: Intel Community's Havana Syndrome Report and its Flawed Assumptions
Dr. James Giordano, 10 March 2023
20. The Time Russians Really Did Target Americans With Microwaves
Politico, 10 March 2023
21. The Pentagon is funding experiments on animals to recreate 'Havana Syndrome'
Politico, 9 March 2023
22. On Havana Syndrome, just because there's no smoking gun, doesn't mean a gun wasn't fired. Kudos to @MarkSZaidEsq for representing victims. I've heard horrific stories from diplomats, intel officials, and their children. The gov't still needs to get to the bottoms of this.
Miles Taylor, 7 March 2023
23. Is the case really closed on Havana Syndrome?
Politico, 7 March 2023
24. Chapter 7: The Two Exits
Project Brazen & PRX, 6 March 2023
25. The cause of 'Havana syndrome' remains elusive
Advisory Board, 6 March 2023
26. Havana Syndrome: Bouncing the Reality Check? (includes transcripts)
Institute for Biodefense Research, 5 March 2023
27. Pentagon still probing what caused 'Havana Syndrome,' even after spy agencies found no smoking gun
Politico, 3 March 2023
28. "They feel betrayed. They feel very much betrayed," attorney Mark Zaid, who represents over two dozen patients with Havana Syndrome, says following the report that it's likely not caused by a foreign adversary or weapon.
CNN (This Morning), 2 March 2023
29. 'Havana syndrome' 'patient zero' tells Fox News he feels gaslit by new Intelligence report
Fox News, 2 March 2023
30. US intelligence community finds no foreign adversary linked to 'Havana syndrome'
Fox News, 2 March 2023
31. If there is no foreign adversary involved, then why is @DeptofDefense mandating reporting #AHI as potential Counterintelligence threat? Especially since @ODNIgov/@CIA refuse to investigate incidents & evidence exists of @FBI being prohibited from doing so.
#Unacceptable
Mark S. Zaid, 1 March 2023
32. House Intelligence Committee Chairman Turner & Ranking Member Himes Respond to "Havana Syndrome" Report by Intelligence Community:
House Intelligence Committee, 1 March 2023

11. New US intelligence community report finds Havana Syndrome not caused by foreign adversary - March 2023

From [5]:

Karine Jean-Pierre, White House Press Secretary: "The work is ongoing".

Joe Khalil: "So, you know, we talked to some of our sources who basically laid out the the fact they're all weapons that exist that could do these kinds of things But again, the Intelligence agencies saying this was not from a foreign adversary. We heard from the CIA director Bill Burns who said he wants to make clear that whatever this is, we have to remember there are real victims who went through real symptoms.

From [7] NEWS ALERT: @MarkSZaidPC reps more than 2 doz federal #AHI victims & family members. Below is our statement in response to IC Assessment findings issued today:

"My firm represents more than two dozen federal AHI victims from within the Intelligence, Military, Law Enforcement and Diplomatic communities who experienced incidents domestically and overseas. This also includes minor children of our dedicated workforce who are also victims of these AHIs. Our representation started a decade ago.

The latest U.S. intelligence assessment lacks transparency and we continue to question the accuracy of the alleged findings. From the origins of these incidents dating back five decades, AHIs occur in the intelligence shadows that shield them from the view of the public. Until the shrouds of secrecy are lifted and the analysis that led to today's assertions are available and subject to proper challenge, the alleged conclusions are substantively worthless. But the damage it has caused to the morale of the victims, particularly by deflecting from the government's failure to evaluate all the evidence, is real and must be condemned.

It is inconceivable based on an overwhelming number of unanswered questions that today's report will serve as the last word. These questions include the need to explain existing evidence of technical anomalies at the time of suspected incidents, reliable evidence of deliberate uninvestigated surveillance and counterintelligence incidents involving AHI intelligence victims and an examination of the high numbers of concerning cancer and other deaths of affected personnel, especially among those who served or worked in Moscow. Today's intelligence assessment is also at odds with private investigations into known movement of foreign intelligence officers in locations where AHIs contemporaneously occurred.

To be clear, the absence of evidence is not evidence of absence Indeed, @NSAGov wrote in 2014 that it was aware of intelligence information that a hostile country had "a high-powered microwave system weapon that may have the ability to weaken, intimidate, or kill an enemy over time and *without leaving evidence.*" (emphasis added)

The full intelligence assessment is already the subject of existing #FOIA litigation brought by my firm for @JMadisonProject & @BrianKarem. @ODNIgov is required to inform the Court by March 20, 2023, as to the status of when a copy of the report will be publicly released.

To its credit, notwithstanding today's IC assessment, @DeptofDefense & @StateDept have

acknowledged its solid support for the victims, and especially their care. We implore all federal agencies with victims to ensure top-of-the line and long-term health care treatment is freely and timely made available to them and their families, as well as award proper compensation for injuries that for some have ended their careers in the line of service."

From [21]:

Two agencies judge that deliberate causal mechanisms are unlikely to have caused AHIs and have low confidence because they judge that radiofrequency (RF) energy is a plausible cause for AHIs, based in part on the findings of the IC Expert Panel and the results of research by some US laboratories.

All agencies acknowledge the value of additional research on potential adversary capabilities in the RF field, in part because there continues to be a scientific debate on whether this could result in a weapon that could produce the symptoms seen in some of the reported AHI cases.

From [22] [Unclassified] XXX XXXX IC Targeting and Collection Efforts Point Away From Adversary Involvement in Anomalous Health Incidents:

XXX FBI specific activity in the United States

...

Opened full investigation to determine if XXX were targeting XXX while they were receiving treatment in the United States.

...

Conducted countersurveillance in support of FBI investigative activities.

References:

1. [The 'Havana Syndrome' mystery and its impact aren't over](#)
The Hill, 8 March 2023
2. [What's likely behind mysterious 'Havana syndrome' that plagued US diplomats](#)
ABC News, 2 March 2023
3. [After the release of a declassified Intelligence Community Assessment on Anomalous Health Incidents \(AHIs\) commonly referred to as "Havana Syndrome", I issued the following statement:](#)
Senator Marco Rubio, 2 March 2023
4. [We spoke w/@Georgetown Chief of Neuroethics James Giordano, who's advised State Dept. on #HavanaSyndrome](#)
[He took issue w/some parts of a new intel report that says Havana likely NOT perpetrated by foreign adversary @NewsNation](#)
[Giordano has worked with #HavanaSyndrome patients who worked in Cuba. He says the technology to weaponize energy and cause Havana symptoms DOES EXIST, and the U.S., China and Russia all the capability.](#)
Joe Khalil, 2 March 2023
5. [US: 'Havana syndrome' not caused by foreign adversary | Morning in America](#)
Newsnation, 2 March 2023

6. [US intelligence agencies rule out foreign attack as cause of 'Havana syndrome'](#)
ABC News Australia, 2 March 2023
7. [NEWS ALERT: @MarkSZaidPC reps more than 2 doz federal #AHI victims & family members. Below is our statement in response to IC Assessment findings issued today.](#)
Mark S. Zaid, 1 March 2023
8. [Havana Syndrome unlikely to have hostile cause, US says](#)
BBC, 1 March 2023
9. ['Havana syndrome' not caused by foreign adversary, US intelligence says](#)
The Guardian, 1 March 2023
10. [U.S. intel review finds no evidence linking foreign adversary to 'Havana syndrome'](#)
NBC News, 1 March 2023
11. [Havana Syndrome: What We Know](#)
The Wall Street Journal, 1 March 2023
12. [US intelligence community cannot link 'Havana Syndrome' cases to a foreign adversary](#)
CNN, 1 March 2023
13. [U.S. intelligence review says "very unlikely" foreign adversary is behind "Havana Syndrome"](#)
CBS News, 1 March 2023
14. [U.S. Intelligence: foreign rivals didn't cause Havana Syndrome](#)
npr, 1 March 2023
15. ['Havana syndrome' not caused by foreign adversary, U.S. intel finds](#)
Reuters, 1 March 2023
16. [Foreign Adversaries 'Very Unlikely' to Blame for Havana Syndrome, Intelligence Review Finds](#)
New York Times, 1 March 2023
17. [Intel agencies: No sign adversaries behind 'Havana syndrome'](#)
ABC News, 1 March 2023
18. [Intelligence review of 'Havana Syndrome' finds no link to foreign adversary](#)
ABC News, 1 March 2023
19. ['Havana syndrome' not caused by energy weapon or foreign adversary, intelligence review finds](#)
The Washington Post, 1 March 2023
20. [DNI Statement on the Intelligence Community Assessment on AHIs - Press Release](#)
Office of the Director of National Intelligence, 1 March 2023
21. [\[Unclassified\] Updated Assessment of Anomalous Health Incidents](#)
National Intelligence Council, 1 March 2023
22. [\[Unclassified\] XXX XXXX IC Targeting and Collection Efforts Point Away From Adversary Involvement in Anomalous Health Incidents](#)
National Intelligence Council, 1 March 2023

12. New Targeted Justice files \$1.3 Billion lawsuit against the DOJ, FBI, & DHS.

References:

1. [Lawsuit filed 11 Jan 2023 Amended](#)
Targeted Justice, January 2023
2. [Targeted Justice files \\$1.3 Billion lawsuit against the DOJ, FBI, & DHS.](#)
Targeted Justice, 11 January 2023

13. **New** Articles and videos - January, February 2023

From [2]

Chapter 5: The Great British Nuke Off

Nicky Woolf (NW) and James Giordano (JG)

JG: Microwave energy disrupts the electrochemical activity of the communication capacity of the brain cells and thereby disrupts what brain cells do functionally. Thought, emotion, behaviours, motor effects, equilibrium, coordination and so forth.

...

NW: Is there a type of microwave weapon out there that can cause this specific symptom profile that the victims in Havana experienced? That means something capable of not just causing the headaches, nausea, hearing and vision impairments, cognitive problems, even brain damage and all that - but also do it in this precisely targeted way?

JG: Yes

...

NW: They wanted a handheld device that could emit pulsed microwaves at a human target. The patent has diagrams of the brain and inner ear. The description reads: "The present invention ... utilizes beamed electromagnetic RF energy ... to interrupt the normal process of human hearing, equilibrium and other senses to produce complete disorientation and confusion." The head of the company that filed the patent declined a request for a formal interview. But they did tell us they built a prototype and even started tests on animals. And ... they said their funding dried up before they could finish development ... because the Marine Corps moved on to a similar project ... with a bigger company.

From [3]

Nicky Woolf about Havana Syndrome starts at 41m25s.

... the fact that people had heard this sound ironically rules out a sonic weapon ... and one thing that a lot of the Havana Syndrome original cohort described was being able to step in and out almost like it's a beam and the sound stops and starts again ...

... we built one and we were able to project a beam of microwave and sort of detect it ... there are several American defense companies that make devices explicitly to do something like this ... so the devices exist ... we've heard from one source they are being deployed actively by certainly the US and that Russia and China had similar kind of development projects ... and it's

actually within the brochures that the American defense companies advertise internally ... loads of countries has have those ... certainly these devices exist and have been deployed ...

From [4]

Dr James Giordano:

The way microwave would need to need to work is it would not have a thermal signature, you want don't to feel heat. And at first, back in 2017 we didn't know that technology was ready, in other words, was it ready for deployable use.

We have learned in fact there are microwave technologies here in the United States and among our economic allies, China and Russia, that are being used for commercial and industrial testing for occupational safety and health, that use very very rapid pulsed lasers to deliver microwave energy without the thermal, without the heat signature.

And what this can do is disrupt a lot of the physiological structures and functions primarily in conductive tissue like nerve.

But it also produces a vibration which is those microwaves literally moving through the substance and in some individuals their physical structures of their inner ear and or the resonances of their bone structures evoke that as perceptible sound.

So yeah, this technology is out there it is at the point of scalable and usable and we think at this point that both an ultrasonic device as well as possibly some form of rapidly pulsed microwave seems to be the responsible entity.

From [7]:

... she started seeing ... some black spots in her vision ... It ... started off being very small, by the next day it was growing ... We started becoming more and more concerned because the spot in her eye was getting larger.

She goes to a doctor the next day.

Cue, Kevin: the ophthalmologist is like ... 'well your retina's definitely bleeding.' And he said 'I've only ever seen this when somebody has a trauma to their head, like a car accident or something ...'

From [14]:

Very informative talk with a big part about pulsed radio frequency with Eric Haseltine, chairman of the Board of the US Technology Leadership Council (USTLC), former NSA employee, even if he cannot say what is still classified. BUT AGAIN, NO WORDS ABOUT CIVILIANS BEING ATTACKED.

[17m35s] It's not at all clear to me that you couldn't if you wanted to come up with virtually undetectable by most normal means way of irradiating people or computers or both using very very short semi-random pulses, because again the amount of average power would not be above the noise level. but the peak power would be very very high and the way you do that is you cram a lot of power under an extremely short period of time, and again the positive mechanism of damage to brain or to the acoustic medium by which I mean the inner ear is thought to be these thermo- explosion, these little shock waves.

References:

1. [Unpacking the 'Havana Syndrome' with Jon Lee Anderson and Adam Entous: podcast and transcript](#)
MSNBC, 23 February 2023
2. [Chapter 5: The Great British Nuke Off \(transcript \)](#)
Project Brazen & PRX, 20 February 2023
3. [What The Hell is 'Havana Syndrome'? | Ash Sarkar Meets Nicky Woolf](#)
Novara Media, 12 February 2023
4. [The curious case of 'Havana Syndrome'](#)
WAMU npr, 25 January 2023
5. [What Really Happened to 'Havana Syndrome' Sufferers?](#)
Gizmodo, 24 January 2023
6. ['Deny Everything': Why the US Hasn't Solved the Mystery of Havana Syndrome](#)
Vice.com, 24 January 2023
7. [The Sound: Mystery of Havana Syndrome - Chapter 1: Jericho \(podcast\)](#)
[Transcript](#)
Project Brazen & PRX, 23 January 2023
8. [Sanjay investigates "Havana Syndrome" Pt. 2 \(video\)](#)
CNN, 23 January 2023
9. [Havana syndrome: sonic attack or all in the mind?](#)
The Sunday Times, 22 January 2023
10. [Havana Syndrome: A New Podcast from VICE](#)
Vice.com, 19 January 2023
11. [Havana Syndrome \(podcast - all episodes\)](#)
Vice.com, 17 January 2023
12. [We Set Out To Solve the Mystery of Havana Syndrome. Here's What We Found.](#)
Vice.com, 17 January 2023
13. [Eric Haseltine - Moscow Station & Havana Syndrome \(video\)](#)
Tim Ventura, 14 January 2023
14. [Havana Syndrome Investigation Explored In Podcast & Docuseries From Project Brazen](#)
Project Brazen, 3 January 2023

14. Articles and videos - November, December 2022

References:

1. [Liberals criticized for inaction on Havana Syndrome suffered by Canadian diplomats in Cuba](#)
Canada Info, 10 December 2022
2. [CIA experiments or electromagnetic attacks from Russia? The mystery of 'Havana Syndrome'](#)
msn.com, 20 November 2022

3. My latest interview, this time for CBS News in Miami, Florida, regarding my work representing #AHI victims.

When will the USG come clean on what it knows? I know for a fact - A FACT - that it is withholding reams of information from the public. #CoverUP

Mark S. Zaid, 2 November 2022

4. The victims are FBI agents working in the Miami area and they say they are being targeted.

WPEC CBS12 News (Twitter), 2 November 2022

5. Florida Cases of Havana Syndrome, FBI agents lawyering up

CBS12 News I-Team, 2 November 2022

15. Articles and videos - September, October 2022

From [13]:

Mark S.Zaid says (17m-20m):

...

This is gross evidence of a coverup by the US government.

I have had access to classified information.

And there is a lot of information that has not been publically revealed.

And if you knew what it is, you would be very upset.

I know that for a fact.

Can't say what it is unfortunately.

So it really sucks.

I'm saying something I can't back it up.'

References:

1. Report Criticizes C.I.A.'s Initial Handling of Havana Syndrome Cases

The New York Times, 14 October 2022

2. CIA inspector general dings agency care of early Havana Syndrome victims

CNN, 14 October 2022

3. State Dept approves first requests for Havana Syndrome compensation - spokesperson

Reuters, 6 October 2022

4. "From what I have seen, there are tons of significant, credible leads that to the best of our knowledge the agencies are not addressing," said Mark Zaid, an attorney who is representing some of the complainants.

Mark S. Zaid, 6 October 2022

5. CNN EXCLUSIVE: Dozens of CIA officers are concerned with the agency's Havana Syndrome investigation. We discuss with @KatieBoLillis and @kylieatwood

CNN, 6 October 2022

6. Exclusive: Dozens of CIA officers accuse intel agency of soft-pedaling its 'Havana Syndrome' investigation

CNN, 5 October 2022

7. [A CIA doctor investigating the mysterious Havana syndrome says he got symptoms of the illness himself](#)
Insider, 26 September 2022
8. [Transcript: Immaculate Concussion, The Truth Behind Havana Syndrome. Aired 8-9p ET](#)
CNN, 25 September 2022
9. [CNN SPECIAL REPORT – “IMMACULATE CONCUSSION: THE TRUTH BEHIND HAVANA SYNDROME”](#)
CNN, 22 September 2022
10. [Richard Nixon exposed to radiation on Moscow trip in 1959, documents reveal](#)
The Guardian, 22 September 2022
11. [US hid fears of radiation in Moscow embassy in 70s from staff, documents revealed](#)
The Guardian, 15 September 2022
12. [Top State Department official DENIES the existence of Havana Syndrome reported by 1,100 diplomats leading to payments of up to \\$200k: ‘We have not identified any outside causality’](#)
Mail Online, 14 September 2022
13. [Conspiracyland: Episode 3: "It’s Not What We Thought It Was" \(podcast\)](#)
Yahoo News, 16 September 2022
14. [Conspiracyland: The Strange Story of Havana Syndrome \(video\)](#)
Yahoo News, 14 September 2022
15. [Top U.S. officials cast fresh doubt on sensational 'Havana syndrome' claims](#)
Yahoo News, 14 September 2022

16. C.I.A. Begins Compensating Victims of Havana Syndrome - August 2022

From [1]:

One victim who has received payments praised the C.I.A. for making the application process easy, but lawyers for other officers have expressed worry that later cases may be harder to adjudicate. Unlike those hurt while serving at the C.I.A. station in Havana, some injured officers have a shorter and potentially less well-documented treatment history, which may make applying for payments more difficult.

References:

1. [C.I.A. Begins Compensating Victims of Havana Syndrome](#)
New York Times, 24 August 2022
2. [I rep almost two dozen fed employees \(& family\) from multiple agencies who have been injured by Anomalous Health Incidents. Seeking compensation under "Havana Act" has been far more complicated & inconsistent than it should be.](#)
Mark S. Zaid, 24 August 2022
3. [“One victim injured in Havana who received the maximum payment said that while the money was not life changing, it had been helpful.. and was an official acknowledgment that](#)

an incident had occurred and caused permanent brain injuries.”

Marc Polymeropoulos, 24 August 2022

17. Articles and videos - July, August 2022

References:

1. Thanks to @Newsy & @SashaIngber for ensuring this story is known about @FBI & Anomalous Health Incidents.
Domestic incidents involving US Govt personnel at multiple agencies are much higher than publicly known.
Mark S. Zaid - 26 August 2022
2. LIVE: Andrea Mitchell Interviews CIA Director William Burns | NBC News
NBC News - 20 July 2022
3. CIA Director backing down from “Havana Syndrome” lie
July 2022, Kawsachun News

18. US to pay Havana Syndrome victims - June 2022

References:

1. Implementation of HAVANA Act of 2021
Department of State, 30 June 2022
2. Canadian government not saying if it will follow U.S. with 'Havana Syndrome' compensation
Ottawa Citizen, 27 June 2022
3. State Department, CIA establish federal payment rules for "Havana Syndrome" victims
CBS News, 24 June 2022
4. State Dept. to pay 6-figure sums to Havana Syndrome victims
National Post, 23 June 2022
5. U.S. to give some 'Havana syndrome' victims six-figure compensation
The Washington Post, 23 June 2022
6. Deputy CIA chief briefs senators on 'Havana Syndrome' as U.S. prepares to pay victims
NBC News, 23 June 2022
7. This will be extraordinarily important for USG officials who lives and careers have been permanently altered with debilitating physical, mental disabilities, documented by medical professionals. My colleagues have suffered terribly. This is long overdue.
Marc Polymeropoulos, 23 June 2022
8. I will be scrutinizing the proposed regulations very closely to make sure AHI/UHI victims are treated similarly and fairly.
I already have concerns that domestic victims will be excluded & I can tell you they exist from multiple federal agencies.
Mark Zaid, 23 June 2022

9. State Dept. to pay 6-figure sums to Havana Syndrome victims

AP News, 23 June 2022

19. **New Articles and videos - May, June 2022**

From [7]:

'The microwave heating causes spatially varying, rapid thermal expansion, which then induces mechanical waves that propagate through the brain, like ripples in a pond ... if those waves interact in just the right way at the center of the brain, the conditions are ideal to induce a traumatic brain injury ... When applying a small temperature increase over a very short amount of time (microseconds), potentially injurious stress waves are created.'

From [5]:

'The potential of these stress waves to initiate injury mechanisms may warrant further investigation. The thermoelastic stress wave mechanism is exemplified by the well-known microwave auditory effect (MAE).'

References:

1. Havana Syndrome: Embassy Intrigue
ZEITmagazin, 30 June 2022
2. Havanna-Syndrom: Gefährliche Botschaften (in German)
ZEITmagazin, 29 June 2022
3. Havanna-Syndrom: Gefährliche Botschaften
ZEITmagazin, 29 June 2022
4. Deputy CIA chief briefs senators on 'Havana Syndrome' as U.S. prepares to pay victims
NBC News, 23 June 2022
5. The puzzle of Havana syndrome, the strange disease affecting North American spies and diplomats
Le Monde, 14 June 2022
6. Some suspected Havana Syndrome victims say they struggle to receive support (video)
CBS News, 31 May 2022
7. "My brain is broken": Former CIA analyst struggling with Havana Syndrome says she has not received promised care
CBS News, 31 May 2022
8. New Research Shows Exposure to High-Powered Microwave Frequencies Can Cause Brain Injuries
SciTechDaily, 21 May 2022
9. Computational modeling investigation of pulsed high peak power microwaves and the potential for traumatic brain injury
29 October 2021, Amy M. Dagro, Justin W. Wilkerson, Thaddeus P. Thomas, Benjamin T. Kalinosky and Jason A. Payne

20. **New** Articles and videos - March, April 2022

From [5]:

Howie, Sacks & Henry has partnered with law firm Waddell Phillips to represent the Canadian Diplomats who have suffered mysterious injuries known as Havana Syndrome while representing Canada in Cuba.

References:

1. [State Department Trims Engineer's 'Havana Syndrome' Bias Suit](#)
Bloomberg Law, 15 April 2022
2. [The bizarre true story of Havana syndrome: covert sonic warfare or a case of mass hysteria?](#)
Telegraph, 15 April 2022
3. [Directed-Energy Weapons Research Becomes Official](#)
IEEE Microwave Magazine - James C. Lin, April 2022
4. [Symptoms reported by Canadians posted in Havana are linked with reduced white matter fibre density](#)
Brain CommunicationsBrain Communications, 7 March 2022
5. [Cracking the Havana Syndrome with Dr. Beatrice Golomb](#)
Green Street News, 1 March 2022
6. ['Havana Syndrome' Lawsuit Covered by International Media](#)
Howie, Sacks & Henry LLP, recent but date unknown
7. [Waddell Phillips and Howie, Sacks and Henry launch lawsuit on behalf of Canadian diplomats for "Havana Syndrome"](#)
Howie, Sacks & Henry LLP, 6 February 2019
8. [Literature Review on Human Bioeffects of Electromagnetic Energy: A Complex Systems Perspective](#)
DevCom Army Research Laboratory - Scott E Kerick, March 2022

21. **New** 'Havana Syndrome' stumps investigators as U.S. officials report injuries on White House grounds - February 2022

This section is about the CBS News 60 Minutes investigative report. This report includes interviews with Havana Syndrome victims and statements of experts.

From [1]:

Olivia Troye, a former Homeland security and counter terrorism advisor to vice-president Mike Pence. In the summer of 2019 when she was inside the White House security perimeter, she felt had been physically struck. 'It was like this piercing feeling on the side of my head ... it was on the right side of my head and I got like vertigo ... I felt unsteady, I was nauseous, I was somewhat disoriented'. The piercing feeling continued. This was followed by a paralyzing panic attack,

which she never had. About a year it happened again a couple of times. 'It was a similar sensation but this time it was very much the feeling of vertigo and dizziness and I felt I couldn't really walk. ... that I was just gonna fall right into the ground.' She didn't report the episodes at that time because she didn't want to believe she was seriously ill.

Another person, a senior member of the national security council, who asked not to name him, was stricken in November 2020 at the same place as Troye, he described the incident to John Bolton. He told Bolton he had disorientation and ringing in the ears and the inability to function, and that he couldn't speak or think clearly. He was taken to an emergency room. Bolton: 'That was a very debilitating attack and similar to what others reported.'

Another person attacked was Miles Taylor who was deputy chief of staff and later chief of staff of the Trump administration Department of Homeland Security. He was hit with the same symptoms described by Olivia Troye. It was late one night in April 2018 around three in the morning and he woke up to a really strange sound. 'Sort of chirping somewhere between what you would think as a cricket or sort of a digital sound.' He went to the window, opened it, looked at the street and saw a white van, the van's breaklights turned on, it pulled up and drove away. The whole episode lasted seven to ten minutes. The next day he felt sick, not able to work. Five weeks later it happened again. The next day he was feeling off balance, out of it, the sort of concussion like symptoms you have from getting knocked very hard. He was just getting to leave to Israel on a congressional delegation. When he got to the airplane he thought I am already nauseous, I don't know if I can do this flight. Taylor heard of another case his. It was US government official who experience similar episodes at their place of residence. This was an individual at the cabinet level in the Trump administration.

In 2019 during a visit by president Trump to London two members of John Bolton's security staff became ill in a hotel. Bolton says this was a deliberate attack. Months later, one of those staff members was overcome again walking her dog in the Washington area.

Robin Garfield was a commerce department official in China. He, his wife and two children were repeatedly hit in China. His daughter was literally falling down multiple times a day. They were evacuated. His family was hit again during their year of treatment in Philadelphia. My wife catapulted out of bed and sprinted down the hallway to check the children. An extremely loud painful sound had woken her up. They moved to a hotel and it happened again. They woke up around 2 AM with strange vibrations in our bodies and a sound. He checked his children and saw an extremely early scene where both were thrashing in their beds, both were asleep but both were kicking and moving aggressively. He put his head next to the head of his daughter and heard a very distinct sound, sort of like water rushing. He checked his son, same sound. He reported to the FBI. He personally knows children of eight other parents who had balance issues, trouble with finding their words, stuttering.

One of the first cases of the Havana Syndrome, assigned to the US embassy in Cuba, talks about his experiences in 2016. He is not allowed to say what federal agency he worked for. They and their families were struck frequently in their homes in the night. The first time it happened all the dogs in the neighbourhood started kicking off barking which is very unusual and then this

loud sound filled my room like my head was slowly getting to start get crushed. And then severe earpain started, it was very painful. Eventually he started blacking out. He has lost vision of one eye, it is because something is wrong in his brain since that time.

Dr. David Relman, helped lead two panels that investigated the injuries. 'This set of cases experienced an abrupt onset of intense pressure or vibration in the face or head, sometimes with the abrupt onset of sound. Victims mention that the sound or feeling of pressure came from one direction.' Dr. David Relman's committee concluded that the mechanism that caused this was pulsed electromagnetic energy, in other words: a focussed beam of microwaves fired from a distance.

James Benford, a physicist and leading authority on microwaves, says the most plausible explanation is that it is a high power microwave weapon. 'There are many kinds and they can go anywhere in size from a suitcase all the way up to a large fracture trailer unit. And the bigger the device, the longer the range. ... Microwaves go through glass, they go through brick, they go through practically everything. The technology has been studied for more than fifty years. It has been developed widely in perhaps a dozen countries. Primary countries are the United States, Russia and China.'

Images below are from this 60 Minutes report: Portable microwave transmitters.

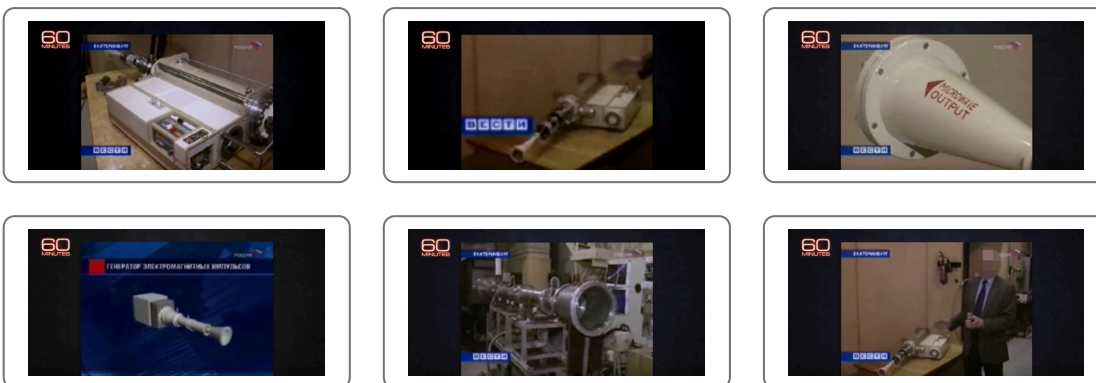

References:

1. ['Havana Syndrome' stumps investigators as U.S. officials report injuries on White House grounds - video](#)
CBS News - 60 Minutes, 21 February 2022
2. [The youngest victims of 'Havana Syndrome'](#)
CBS News - 60 Minutes Overtime, 20 February 2022
3. [Unexplained injuries similar to previous 'Havana Syndrome' cases afflicted U.S. officials on White House grounds](#)
CBS News - 60 Minutes, 17 February 2022

22. New Declassified US intelligence community report says 'pulsed electromagnetic energy' could cause Havana Syndrome - February 2022

From [1]:

Findings

Pulsed electromagnetic energy, particularly in the radiofrequency range, plausibly explains the core characteristics, although information gaps exist.

There are several plausible pathways involving various forms of pulsed electromagnetic energy, each with its own requirements, limitations, and unknowns. For all the pathways, sources exist that could generate the required stimulus, are concealable, and have moderate power requirements. Using nonstandard **XXXXX** antennas and techniques, the signals could be propagated with low loss through air for tens to hundreds of meters, and with some loss, through most building materials. **XXXXX**

XXXXX Stimulation and disruption of these biological systems has been credibly demonstrated in cells and tissues, and persons accidentally exposed to radiofrequency signals described **XXXXX** sensations similar to the core characteristics. However, there is a dearth of systematic research on the effects of the relevant electromagnetic signals on humans.

Ultrasound also plausibly explains the core characteristics, but only in close-access scenarios and with information gaps.

The required energy can be generated by ultrasonic arrays that are **XXXXX** portable, and produce a tight beam. Ultrasound propagates poorly through air and building materials, restricting its applicability to scenarios in which the source is near the target, **XXXXX** It could couple to the body through the external auditory canal, interstitial spaces, or the vestibular apparatus of the inner ear. Ultrasound is used to open the blood-brain barrier in medical procedures, and acoustic stimulation of the aforementioned anatomical areas could produce symptoms consistent with AHIs. Studies of "ultrasound sickness" and related audiovestibular symptoms have reached mixed conclusions, but the panel was presented with **XXXXX** independent, first-hand accounts in which researchers were exposed to high-power ultrasound beams and subsequently experienced some of the core characteristics.

From [5]:

Such sources exist that "are concealable and have moderate power requirements," the report said. "Using non-standard antennas and techniques, the signals could be propagated with low loss" through the air and building materials.

Ultrasound also could account for the symptoms, but only if a victim was in close proximity to the beam because ultrasound "propagates poorly through the air and building materials," it continued.

Psychosocial factors - which include work demands, stress and depression - cannot alone account for the core symptoms of Havana Syndrome, it said.

Peter Mooring note: What they in fact say is that pulsed microwaves are going through walls, people can be attacked through walls. I said this already in 2007 when I created the STOPEG website.

References:

1. [Executive Summary - DECLASSIFIED by DNI Haines on 1 February 2022](#)
DECLASSIFIED by DNI Haines, 1 February 2022
2. [US intelligence community report says 'pulsed electromagnetic energy' could cause Havana Syndrome](#)
CNN, 3 February 2022
3. [Panel of experts concludes microwave energy is most likely causing 'Havana Syndrome' \(video\)](#)
NBC News, 3 February 2022
4. [External energy source may explain 'Havana syndrome,' panel finds, renewing questions about possible foreign attack](#)
The Washington Post, 2 February 2022
5. [U.S. diplomats, spies may have been hit by electromagnetic energy -report](#)
Reuters, 2 February 2022
6. [Panel Says Some Havana Syndrome Cases May Stem From Radio Energy](#)
The New York Times, 2 February 2022
7. [Havana Syndrome could be caused by pulsed energy devices – US expert report](#)
The Guardian, 2 February 2022

23. Havana Syndrome like attacks on Paris, Geneva, US diplomats - January 2022

From [1]:

The Wall Street Journal on Thursday reported additional illnesses among officials serving in U.S. diplomatic missions in Paris and Geneva, where the United States and Russia held security talks on Monday over Moscow's troop buildup near the Ukraine border.

References:

1. [Blinken says U.S. working on Havana Syndrome after diplomats' illnesses in Paris, Geneva](#)
Reuters, 13 January 2022
2. ['Havana syndrome': US baffled after new cases in Europe](#)
BBC News, 13 January 2022
3. [Four US diplomats - three in Geneva and one in Paris - are struck with suspected 'Havana Syndrome'](#)
MailOnline, 13 January 2022
4. [U.S. Diplomats in Geneva, Paris Struck With Suspected 'Havana Syndrome'](#)
The Wall Street Journal, 13 January 2022

24. **New** Articles and videos - January, February 2022

From [2]:

High-ranking Homeland Security officials in the Trump administration say they were overcome with feelings of vertigo, confusion and memory loss while on White House grounds and in their Washington, D.C.-area homes. The incidents and symptoms they describe are similar to the "Havana Syndrome" that has been reported by American diplomats in foreign countries since 2016.

From [3]:

At 18:40. Why would such devices be in operation. Well this too I think is a little above my pay grade and out of my sandbox but this fight is to understand that these types of devices can be used for surveillance and or they can be used either kinetically or non-kinetically for disruptive effects. What do we mean by that. What we mean is there are a number of nations worldwide that have dedicated effort to employing these devices for testing organic and inorganic substances primarily in the occupational and commercial range. If we take a look at these nations include the United States and many of its allies, China, Russia among others. So the technology exists we know the technology is being employed at least in part for the evaluation of vulnerability and volatility for organic and inorganic substances. To do what. Well this is where its gets interesting because what may be possibly going on here in terms of the actual effects comes to these conclusions this probably represented most of course based upon our probabilistic inference a non-accidental exposure to some form of directable energy source. Acoustic effects possibly.

43:42. What steps do recommend for civilian patients who've been given diagnoses similar to those of embassy personnel by dr Hoffer and his group in Miami. Yeah, that's a very very good question and I must you I receive a number of emails, a number of correspondences from individuals who have reports in which they're reporting certainly symptoms and in some cases validateable signs. I think what becomes very very important is for them to seek clinical assistance see clinical aid first and foremost. Why. Well clearly they're suffering. Something is wrong. Find out what is wrong that also helps to provide objective evidence that there are dysfunctional parameters and abnormalities which would then be important to feed if you will up the chain so these can then be further evaluated and there are a number of evaluative programs as we know operative right now in the United States into which that information would then be uptaken so the individuals might then progress into the verification validation pipelines.

From [5]:

I (Mark Zaid) filed a federal Freedom of Information Act lawsuit today. In fact access to classified NSA information that they told me about almost a decade ago and members of congress appropriately today criticizing the CIA report saying that it contradicted everything they were

being told behind the scenes and now I also have some whistleblowers that I hope will turn into something substantive challenging the very report that was issued.

From [6]:

Mark Zaid, a lawyer for a number of those affected with the disease, told WebMD that the symptoms first originated in Americans not stationed in or around Cuba. 'It started long before Havana,' Mr Zaid told the website. 'It was just those incidents that brought it to light.'

From [7]:

In about two dozen cases, however, the agency can't rule out foreign involvement, including many of the cases that originated at the U.S. Embassy in Havana beginning in 2016.

References:

1. [Column: Are electromagnetic weapons involved? Taking victims of 'Havana syndrome' seriously](#)
Los Angeles Times, 24 Februari 2022
2. [Trump-era officials reported Havana Syndrome symptoms in DC](#)
New York Post, 20 February 2022
3. [Dr James Giordano's Presentation At UTSW's Havana Syndrome Webinar\(FULL\)](#)
UTSW-Dallas, 12 February 2022
4. [Havana syndrome has 'dramatically hurt' morale, US diplomats say](#)
The Guardian, 10 January 2022
5. [Cuban official reacts to CIA report on Havana Syndrome](#)
CNN, 27 January 2022
6. [Opinion: The 'Havana syndrome' is still a mystery. It is too soon to stop investigating.](#)
The Washington Post, 23 January 2022
7. [Havana Syndrome lawyer not convinced of CIA's findings | NewsNation Prime](#)
NewsNation, 21 January 2022
8. [CIA says 'Havana Syndrome' not result of sustained campaign by hostile power](#)
NBC News, 20 January 2022
9. [US still unsure who's behind Havana Syndrome attacks, Blinken says](#)
Independent, 13 January 2022
10. [U.S. Refines Tool to Evaluate Havana Syndrome Cases](#)
The New York Times, 13 January 2022
11. [U.S. Diplomats in Geneva, Paris Struck With Suspected 'Havana Syndrome'](#)
The Wall Street Journal, 13 January 2022

25. Mark Lenzi v. United States Department of State, and Antony J. Blinken - December 2021

Mark Lenzi is a State Department security officer who worked in the U.S. Consulate in Guangzhou, China.

From [1]:

Around November 2017, approximately 15 months after they arrived in Guangzhou, Mr. Lenzi was injured in the line of duty. Mr. Lenzi and his wife and children began experiencing sudden and unexplained mental and physical symptoms, including headaches, lightheadedness, nausea, nosebleeds, sleeplessness, and memory loss. Mr. Lenzi verbally complained of these symptoms to his superiors in Guangzhou through the Spring of 2018.

...

On or about May 26, 2018, Mr. Lenzi contacted his former neighbor, who had been medevac'd to University Pennsylvania Hospital in Philadelphia. Mr. Lenzi informed her of the numerous symptoms he and his family had been experiencing over the past six months. After Mr. Lenzi described their short-term memory loss, Mr. Lenzi's former neighbor stopped him and said that Mr. Lenzi needed to get himself and his family out of their apartment 'right now.' She went on to say that she had pleaded with the State Department on three different occasions to inform and get her American consulate neighbors out of the Tower 7 Apartment Complex in Guangzhou, but that each time the State Department did nothing. She agreed with Mr. Lenzi that their American diplomatic colleagues should be warned about the potential risk to their health and safety.

...

Mr. Lenzi therefore has the right to 'file a civil action in an appropriate United States District Court in accordance with § 1614.407(b)' with respect to each of the EEO Complaints described above.

...

F. Award Plaintiff financial compensation for emotional distress, pain, and suffering;

...

From [2]:

The government, Mr. Lenzi also said, has readings that show the presence of dangerous levels of microwave energy in China. In an unclassified workers' compensation report he filed with the Labor Department, Mr. Lenzi recounted how his neighbor in China used a commercial detector to record high levels of microwave energy in the apartment next to his.

...

But follow-up tests by the government used a classified device widely known not to be as reliable at detecting directed energy, said Mr. Lenzi, whose work involves countering foreign eavesdropping including by using directed energy. When the government says directed energy is a theory but there is no evidence, 'That is simply not true,' Mr. Lenzi said. 'They have readings, especially in Guangzhou,' he said.

From [4]:

Mark Lenzi believes he was targeted because of his work. He uses top secret equipment to analyze electronic threats to diplomatic missions.

Mark Lenzi: There is no shadow of a doubt in my mind that this was a directed attack against my neighbor and I.

His neighbor was Catherine Werner, who lived one floor up. She's a U.S. Commerce Department trade officer who promoted American business from the Guangzhou Consulate.

Catherine Werner: I woke up in the middle of the night. I could feel this sound in my head. Um, it was intense pressure on both of my temples. At the same time, I heard this low humming sound, and it was oscillating. And I remember looking around for where this sound was coming from, because it was painful.

Scott Pelley: When did you first notice that you weren't feeling well?

Catherine Werner: October of 2017, I started to get hives all over my body. Really bad hives. I woke up with headaches every day. Um, I started to feel tired. The simplest things would just make me very, very tired.

Scott Pelley: Were these symptoms growing worse over time?

Catherine Werner: They were. Yes. My symptoms would get so bad that I would throw up, or I would wake up with nosebleeds.

She says even her dogs were throwing up blood. Werner assumed her illness was connected to China's toxic smog. She didn't know it at the time but her symptoms were the same that American officials in Havana had suffered since 2016. The U.S. Embassy there is all but closed as a result.

Catherine Werner: We hadn't heard about what happened in Cuba. I mean, there were headlines in the news about hearing loss and um, attacks to our diplomats, but we didn't know the details. Catherine Werner became so ill, her mother traveled from the U.S. to live with her.

Catherine Werner: She spent almost three months with me. During that time she also got very ill. Um, and she and I shared the same symptoms.

Scott Pelley: What sort of symptoms did your mother have?

Catherine Werner: Headaches and um, ringing in our ears. Um, we also started to both um, have difficulty recalling words.

After reporting her experiences, Werner was medically evacuated to the U.S. for treatment. U.S. agencies are investigating, but Mark Lenzi has a theory.

Mark Lenzi: This was a directed standoff attack against my apartment.

Scott Pelley: It was a weapon?

Mark Lenzi: Oh, of course it was a weapon.

Scott Pelley: An energy weapon--

Mark Lenzi: Absolutely.

Scott Pelley: What sort of energy is this that we're talking about?

Mark Lenzi: I believe it's RF, radio frequency energy, in the microwave range.

References:

1. [Mark Lenzi v. United States Department of State, and Antony J. Blinken - December 2021, United States Secretary of State](#)

2. [Review Finds No Answers to Mystery of Havana Syndrome](#)
The New York Times, 3 December 2021
3. [State Department tested diplomats for 'directed energy exposure' years before telling Congress](#)
Politico, 25 October 2021
4. [Brain trauma suffered by U.S. diplomats abroad could be work of hostile foreign government](#)
CBS News, 17 March 2019
5. [Diplomat to donate brain to science after suffering mysterious injury in China](#)
New York Post, 11 March 2019

26. **New** Articles and videos - November, December 2021

From [6]:

The former first lady describes arriving in Heiligendamm (the first couple was staying in a villa on the Grand Hotel Heiligendamm compound). But, she writes, 'by the afternoon of [June 7] I could barely stand up. My head inexplicably throbbed; I was horribly dizzy and nauseated. I went to bed, pulled up the covers, **and for several hours felt so awful that I might die right there in the hotel room.**' Mrs. Bush continues, 'Over the next day nearly a dozen members of our delegation were stricken, even [former President George W. Bush], who started to feel sick during an early morning staff briefing.' Mrs. Bush's memoir notes that 'for most of us, the primary symptoms were nausea or dizziness, but one of our military aides had difficulty walking and a White House staffer lost all hearing in one ear.' Suspecting a possible poison attack, the Secret Service 'went on full alert.' Noting that former President Bush 'almost never gets sick,' Mrs. Bush recalls that her husband 'felt so ill that he met with [then-French President Nicolas] Sarkozy in his hotel room and did not even stand up to greet him.'

References:

1. [Biden signs off on \\$30 million in funding for victims of Havana syndrome, the mysterious illness officials believe is caused by directed-energy attacks](#)
Business Insider, 28 December 2021
2. [Havana Syndrome: Why is the mysterious illness plaguing US officials?](#)
The Telegraph, 24 December 2021
3. [Fighting An Invisible Enemy: The Voices Of Havana Syndrome](#)
NBC News, 23 December 2021
4. [Legal, financial fights mount as 'Havana Syndrome' goes unsolved](#)
NBC News, 22 December 2021
5. [NEUROWAR IS HERE!](#)
NAVAL POSTGRADUATE SCHOOL - Joshua D. Gramm and Brian A. Branagan, December 2021

6. George W. Bush, his wife and their delegation may have been the victims of Russia-induced Havana Syndrome at 2007 G-8 summit, report claims
Daily Mail, 8 December 2021
7. Was George W. Bush a 2007 victim of Russia-induced 'Havana Syndrome'?
Washington Examiner, 7 December 2021
8. Review Finds No Answers to Mystery of Havana Syndrome
The New York Times, 3 December 2021
9. Canada diplomats say Ottawa mishandled 'Havana Syndrome' crisis
MSN, 1 December 2021
10. Havana Syndrome: FBI warns staff amid reports of symptoms among agents
The Guardian, 25 November 2021
11. FBI acknowledges some agents may have Havana Syndrome symptoms
NBC News, 24 November 2021
12. CIA director warns Russian spies of 'consequences' if they are behind 'Havana Syndrome' incidents
The Washington Post, 24 November 2021
13. The Secrets of the So-Called "Havana Syndrome"
The Nation, 17 November 2021

27. Four Havana Syndrome diplomats got permission from the State Department to talk about their experiences - October 2021, December 2021

From [1]:

From the video on this page: Fighting an Invisible Enemy: The voices of Havana Syndrome.

- [07:25] There is nothing in the world that is worse than being a victim that everybody doubts.
- [09:40] The Havana Syndrome individuals had brain injuries that were very similar to a concussion.
- [10:10] This is not psychosomatic.
- [14:00] We looked at four possible mechanisms but came up with one we thought most possible and that was pulsed microwave energy.
- [14:20] The National Academy of Sciences report was really helpful and saying yes it is our belief that these are directed energy attacks.

From [2]:

'I felt like I was being struck with something,' she said. 'Pain that I have never felt before in my life ... mostly in my head and in my eyes.... It was as if I had been seized by some invisible hand and I couldn't move.'

Onufer and two of her former colleagues in Havana, a married couple named Kate Husband and Doug Ferguson, spoke to NBC News about their experiences after getting permission from the

State Department. They want the world to know that what happened to them in Havana caused real suffering and documentable injuries, and that those who insist this must be a case of mass psychosis are wrong.

References:

1. [Legal, financial fights mount as 'Havana Syndrome' goes unsolved](#)
NBC News, 22 December 2021
2. ['Seized by some invisible hand': What it feels like to have Havana Syndrome](#)
NBC News, 13 October 2021

28. Havana Syndrome like attacks on Bogota, Colombia, US embassy staff - October 2021

From [2]:

The incidents, which are now among hundreds the US is investigating, come as Secretary of State Tony Blinken is planning to visit Bogota next week. State Department spokesperson Ned Price would not comment on reported incidents in Colombia or on Blinken's upcoming travel during the department briefing on Tuesday.

From [3]:

The US embassy in Bogota, one of the largest in the world, includes a strong contingent of agents working in both intelligence and counter-narcotics operations, in addition to career diplomats and personnel.

Secretary of State Antony Blinken is scheduled to visit the country on October 20.

References:

1. [Havana syndrome reported at US embassy in Colombia](#)
BBC News, 13 October 2021
2. [US officials reported Havana syndrome symptoms in Colombia](#)
CNN, 13 October 2021
3. [Colombia to leave 'Havana Syndrome' embassy probe to US](#)
AlJazeera, 13 October 2021
4. [Havana Syndrome Hits at Least Five U.S. Families Connected to Embassy in Colombia](#)
The Wall Street Journal, 12 October 2021

29. Biden signs bill giving Havana Syndrome victims better medical care - October 2021

From [1]:

To qualify, a document published by the State Department says applicants must have sustained “an acute injury to the brain such as, but not limited to, a concussion, penetrating injury, or as the consequence of an event that leads to permanent alterations in brain function,” a medical diagnosis of a traumatic brain injury, or the acute onset of new persistent, disabling neurologic symptoms.

The injury also must have occurred on or after Jan. 1, 2016, and it must have happened while the impacted person or the victim’s direct family member was working for the department.

References:

1. [What's likely behind mysterious 'Havana syndrome' that plagued US diplomats](#)
ABC News, 2 March 2023
2. [S.1828 - HAVANA Act of 2021](#)
Congress.gov, 8 October 2022
3. [Statement of President Joe Biden on Signing HAVANA Act Into Law](#)
The White House, 8 October 2021
4. [Biden signs bill that will give victims of mysterious 'Havana syndrome' better medical care](#)
CNN, 8 October 2021
5. [Biden signs bill to boost support for "Havana Syndrome" victims](#)
CBS News, 8 October 2021

30. Havana Syndrome like attacks on Serbia, CIA officer - September 2021

From [1]:

A CIA agent in Serbia is believed to have suffered a directed-energy attack after experiencing symptoms consistent with the condition known as 'Havana syndrome' that has affected 200 US officials worldwide.

References:

1. [CIA agent in Serbia sent home with 'Havana syndrome'](#)
The Times, 29 September 2021
2. [Havana Syndrome Attacks Widen With CIA Officer’s Evacuation From Serbia](#)
The Wall Street Journal, 28 September 2021

31. Ryan Conlon attempted to sue the CIA, DOD, Air Force for attacking him with Direct Energy Weapons citing the Havana Syndrome Act - September 2021

From [1]:

Ryan Conlon shared the recent court decision he received as he attempted to sue the CIA, the DOD, and the Air Force for his injuries. The judge ultimately ruled against him. This was his second attempt. He says he filed last year also with the same result.

What is interesting about his filing this time is that he cited the Havana Syndrome Act of 2021 and microwave and directed energy weapons in his complaint. These were not mentioned in the judge's decision.

From [2]:

Plaintiff Ryan Matthew Conlon asserts that the named defendants are responsible for attacking him 'with a D.E.W. a Direct Energy Weapon, using Microwaves.' ECF No. 1 at 4. He claims that he is a 'non-consensual Test Subject of the C.I.A., the D.O.D., and the U.S. Airforce' and that he has suffered 'Brain Injuries' as evidenced by tinnitus, chronic headaches, nausea, inflammation of the brain, dizziness, and 'ear popping.' ECF No. 1-1 at 2, He states he has 'Havana Syndrome.' Id.

References:

1. [RYAN CONLON'S DAY IN COURT](#)

PATCS (People Against Covert Torture & Surveillance) International, 24 September 2021

2. [CONLON v. MILLER](#)

[RYAN MATTHEW CONLON, Plaintiff, v. CONNOR MILLER, DOD Analyst, C.I.A. INSPECTOR GENERAL, DOD INSPECTOR GENERAL, US AIRFORCE INSPECTOR GENERAL, Defendants.](#)
Leagle, 22 September 2021.

32. Havana Syndrome like attacks on India, CIA team member - September 2021

References:

1. [Member of CIA chief's team reported Havana syndrome symptoms on recent trip to India](#)

CNN, 21 September 2021

2. [CIA director's team member reported Havana Syndrome symptoms during India trip](#)

NBC News, 21 September 2021

33. Articles and videos, September - October 2021

From [4]:

'I felt like I was being struck with something,' she said. 'Pain that I have never felt before in my life ... mostly in my head and in my eyes.... It was as if I had been seized by some invisible hand and I couldn't move.'

Onufer and two of her former colleagues in Havana, a married couple named Kate Husband and Doug Ferguson, spoke to NBC News about their experiences after getting permission from the

State Department. They want the world to know that what happened to them in Havana caused real suffering and documentable injuries, and that those who insist this must be a case of mass psychosis are wrong.

References:

1. [Is 'Havana Syndrome' an 'Act of War' or 'Mass Hysteria'?](#)
New York Times, 26 October 2021
2. [State Department tested diplomats for 'directed energy exposure' years before telling Congress](#)
Politico, 25 October 2021
3. [Long before Havana Syndrome, the U.S. reported microwaves beamed at an embassy](#)
npr, 21 October 2021
4. ['Seized by some invisible hand': What it feels like to have Havana Syndrome](#)
NBC News, 13 October 2021
5. [Germany investigates possible 'Havana Syndrome' sonic attack on U.S. Embassy staff](#)
The Washington Post, 9 October 2021
6. [Havana syndrome: Berlin police probe cases at US embassy](#)
BBC News, 9 October 2021
7. [U.S. investigators increasingly confident directed-energy attacks behind Havana Syndrome](#)
Politico, 8 October 2021
8. [CIA 'removes Vienna boss' over Havana syndrome outbreak](#)
BBC News, 24 September 2021
9. [U.S. diplomat overseeing 'Havana Syndrome' response leaving after 6 months](#)
CBS News, 23 September 2021
10. [Symptoms of the "Havana syndrome"](#)
Military Review, 23 September 2021
11. ['Havana Syndrome' Becomes 'Unexplained Health Incidents' As U.S. Backs Down on Blaming Cuba](#)
Newsweek, 13 September 2021
12. ['Havana syndrome' and the mystery of the microwaves](#)
BBC, 9 September 2021

34. Havana Syndrome like attacks on Hanoi, Vietnam, US embassy - August 2021

References:

1. [Possible Havana syndrome incident delayed Harris flight to Vietnam](#)
CNN, 26 August 2021
2. [2 U.S. diplomats to be evacuated from Vietnam after 'Havana Syndrome' incidents](#)
NBC News, 24 August 2021

35. Havana Syndrome like attacks on Berlin, Germany, US officials - August 2021

From [1]:

'At least two US officials stationed in Germany have required medical attention after developing symptoms of an illness known as Havana Syndrome. Symptoms are said to include nausea, severe headaches, ear pain, fatigue, insomnia and sluggishness.'

References:

1. [CNN Interviews Top Neurologist James Giordano Over 'Havana Syndrome' \(video\)](#)
CNN, 25 August 2021
2. [US rocked by mystery syndrome: Panic as officials in Berlin report worrying symptoms](#)
Mail Online, 19 August 2021
3. [Has Havana syndrome struck in Berlin? Two US officials are left unable to work after suffering nausea, severe headaches, ear pain, fatigue and insomnia](#)
Express, 18 August 2021
4. [U.S. Officials in Germany Hit by Havana Syndrome](#)
The Wall Street Journal, 18 August 2021
5. [US officials in Berlin report potential 'Havana syndrome' cases](#)
Politico, 18 August 2021

36. Articles and videos - July, August 2021

From [1]:

'There have also been unconfirmed cases of the syndrome in Poland, Taiwan, Georgia, Colombia and Uzbekistan.

Targets appear to have been followed, as the symptoms persisted even after they were moved to new accommodation.

One victim in Europe was reportedly diagnosed with the sort of brain injury seen in people exposed to the shockwaves from explosions. The target described piercing ear pain, high-pitched electronic-sounding noise and pressure in the ears.'

References:

1. [Has China created a sonic supergun? US officials hit by mystery sickness after identical attacks of two embassies, and 130 spies and diplomats targeted around the world. Now experts believe there could be a terrifying explanation...](#)
Dailymail.co.uk, 27 August 2021
2. [Another Canadian diplomat reports Havana syndrome 'attack'](#)
Ottawa Citizen, 25 August 2021

3. [2 U.S. diplomats to be evacuated from Vietnam after 'Havana Syndrome' incidents](#)
NBC News, 24 August 2021
4. [Top U.S. officials meet to discuss "Havana Syndrome" as cause remains unclear](#)
CBS News, 9 August 2021
5. [U.S. intensifies efforts to address 'Havana Syndrome,' but answers remain elusive](#)
CBS News, 27 July 2021
6. [Havana Syndrome Task Force to Be Led by Veteran of Hunt for Bin Laden](#)
The Wall Street Journal, 21 July 2021
7. [As many as 200 Americans have now reported possible symptoms of 'Havana Syndrome,' officials say](#)
NBC News, 20 July 2021

37. Havana Syndrome like attacks on Vienna, Austria, US diplomats - July 2021

From [1]:

'Some of the patients described feeling as though they were standing in an invisible beam of energy. Many of them suffered debilitating symptoms, from headaches and vertigo to vision problems.

...

The first possible syndrome case in Vienna was reported a couple of months after Biden's Inauguration. That case and subsequent ones were reported to officials in Washington soon after they occurred. But the Biden Administration decided not to announce the Vienna outbreak—officials were concerned that any public disclosure about the cases would hamper ongoing U.S. intelligence and law-enforcement investigations, which are still under way in Vienna.'

From [2]:

'Vienna has long been a centre for diplomatic activity and has had a reputation as a hotspot for espionage, particularly during the Cold War. ... The city is currently hosting indirect talks between Iran and the US over attempts to resurrect the 2015 Iran nuclear deal. Cases of the condition have been reported elsewhere in the world, but US officials say the numbers in Vienna are greater than in any other city apart from Havana.'

References:

1. [Vienna Is the New Havana Syndrome Hot Spot](#)
The New Yorker, 16 July 2021
2. ['Havana syndrome'-like mystery illness affects Vienna US diplomats](#)
BBC, 18 July 2021
3. [Austria investigating reported 'Havana syndrome' cases among U.S. envoys](#)
Reuters, 17 July 2021

4. [Austria probes reports of Havana Syndrome among US diplomats in Vienna](#)
CNN, 19 July 2021

38. Senate passes bill to aid Havana Syndrome attack victims - June 2021

From [1]:

'The Senate on Monday unanimously passed a bill that would boost medical care for American diplomats and spies who develop mysterious brain injuries amid an uptick in suspected directed-energy attacks on U.S. personnel at home and abroad.'

References:

1. [Senate passes bill to aid directed-energy attack victims](#)
Politico, 7 June 2021

39. Articles and videos - May, June 2021

From [1]:

'It could be a device that is as big as fitting into a vehicle or small enough to be carried in a backpack.' ... The US, Russia, China .. and Israel also has the same technology.'

From [2]:

The cases are sometimes collectively referred to as 'Havana syndrome.' But Mark Zaid, a lawyer in Washington, DC, who represents several of those affected, says that is a misnomer because incidents like these had been going on long before the public became aware of the cluster of cases in Havana. One of his clients, a former National Security Agency employee named Michael Beck, was affected while working in a classified hostile country back in 1996.

Beck and a colleague both went on to develop a rare form of Parkinson's disease that Beck attributed to an attack. 'It started long before Havana,' Zaid says. 'It was just those incidents that brought it to light.'

Giordano and Zaid both agree that there is a big psychological component to the phenomenon, especially in the years since the cases in Havana came to light. Each of them gets multiple calls or emails every week from people who think they might have been targeted by the same kind of attack. Most have no plausible connection to any suspected threats. And Giordano has referred only two such cases for further study.

From [6]:

At the end of the day, he left the building and headed toward his car, which was parked a few hundred yards away, along the Ellipse, between the White House and the Washington

Monument. As he walked, he began to hear a ringing in his ears. His body went numb, and he had trouble controlling the movement of his legs and his fingers. Trying to speak to a passerby, he had difficulty forming words. "It came on very suddenly," the official recalled later, while describing the experience to a colleague. "In a matter of about seven minutes, I went from feeling completely fine to thinking, Oh, something's not right, to being very, very worried and actually thinking I was going to die."

From [7]:

David A. Relman of Stanford University led the National Academy of Sciences study: 'It is a high energy, very short pulsed, delivery of this microwave energy. This is used for example by militaries for RADAR ... (cut) ...'

Marc Polymeropoulos, former CIA officer, attacked in Russia in 2017: 'There is this this conventional wisdom that this is a portable weapon, a microwave weapon, we knew the Russians and the Soviet Union certainly developed and tested for a long time, and it is designed you know to incapacitate. The majority of US officials, including the intelligence community, believe it's the Russians .. (cut) ...'

References:

1. [Directed-energy attacks: The invisible threat Congress wants answers on \(video\)](#)
Politico, 7 June 2021
2. [Havana Syndrome Attacks Leave Baffling Symptoms](#)
WebMD, 11 June 2021
3. [As mystery over 'Havana Syndrome' lingers, a new concern emerges](#)
NBC News, 6 June 2021
4. [Microwave weapons that could cause Havana Syndrome exist, experts say](#)
The Guardian, 2 June 2021
5. [US officials confirm 130 incidents of mysterious Havana syndrome brain injury](#)
The Guardian, 13 May 2021
6. [Are U.S. Officials Under Silent Attack?](#)
The New Yorker, 31 May 2021
7. [US investigates energy attacks targeting brains of American citizens](#)
Fox News, 3 May 2021

40. Senate Intel leaders say mysterious directed energy attacks appear to be increasing - April 2021

From [1]:

'The leaders of the Senate Intelligence Committee warned Friday that mysterious invisible attacks that have caused debilitating symptoms appear to be on the rise against US personnel.'

References:

1. [Senate Intel leaders say mysterious directed energy attacks appear to be increasing](#)
CNN, 30 April 2021

41. US investigating possible mysterious directed energy attack near White House - April 2021

From [1]:

'Federal agencies are investigating at least two possible incidents on US soil, including one near the White House in November of last year, that appear similar to mysterious, invisible attacks that have led to debilitating symptoms for dozens of US personnel abroad.'

References:

1. [US investigating possible mysterious directed energy attack near White House](#)
CNN, 29 April 2021

42. U.S. probing suspected directed-energy attack on government personnel in Miami - April 2021

From [1]:

'In Miami, several people reported symptoms similar to those exhibited by American spies and diplomats in Cuba starting in 2016 that became known as "Havana syndrome," three people said. It was unclear which agency the people in the Miami incident belonged to.'

'The attacks, which have caused varying symptoms including brain damage, are difficult to track and attribute with confidence due to their nature. The devices involved can be small and portable, and the symptoms can appear similar to other illnesses.'

Peter Mooring note: I often stated that there also must be portable devices, and that symptoms can appear similar to other illnesses.

References:

1. [U.S. probing suspected directed-energy attack on government personnel in Miami](#)
Politico, 29 April 2021

43. U.S. troops increasingly vulnerable to directed-energy attacks, Pentagon tells lawmakers - April 2021

From [1]:

'The Pentagon warned lawmakers this week about the growing and urgent threat of directed-energy attacks on U.S. troops in the Middle East and elsewhere, according to four people briefed on the matter.'

References:

1. [U.S. troops increasingly vulnerable to directed-energy attacks, Pentagon tells lawmakers](#)
Politico, 22 April 2021

44. The Pentagon Fears That Deadly Microwave Weapons Are Undetectable - March 2021

From [1]:

'Now the U.S. military wants a sensor that will alert soldiers when they are being attacked by microwave weapons. Because soldiers may not even realize they are under attack by a beam that is invisible to the eye, but painfully apparent to the brain.'

References:

1. [The Pentagon Fears That Deadly Microwave Weapons Are Undetectable](#)
Forbes, 2 March 2021

45. Articles and videos - March, April 2021

References:

1. [Canadian diplomats say their government is withholding info on more 'Havana Syndrome' brain injury cases](#)
NBC News, 29 April 2021
2. [Canadian officials not disclosing 'at least 3' new Havana syndrome cases: letter](#)
GlobalNews, 27 April 2021

46. Articles and videos - January, February 2021

From [2]:

'... And so effectively there is no way to protect either soldiers or diplomats from this type of weapons unless they are completely encased in metal?'. Professor Dr. Edl Schamiloglu of the University of New Mexico: 'Right'.

References:

1. ELECTROMAGNETIC PERSONNEL INTERDICTION CONTROL METHOD AND SYSTEM

Patent No.: US 7.841,989 B2

United States Patent, 30 November 2010

Note(s): This patent was mentioned in the video 'The Havana Syndrome: Return of the Cold War?'

2. The Havana Syndrome: Return of the Cold War? (video)

Global Santa Fe, 21 January 2021

47. Articles and videos - November, December 2020

From [1] Experts suggest US embassies were hit with high-power microwaves – here’s how the weapons work:

Edl Schamiloglu, Professor of Electrical and Computer Engineering, University of New Mexico: '... Two good examples are Boeing’s Counter-electronics High-powered Microwave Advanced Missile Project (CHAMP), which is a high-power microwave source mounted in a missile, and Tactical High-power Operational Responder (THOR), which was recently developed by the Air Force Research Laboratory to knock out swarms of drones. ...'

References:

1. Experts suggest US embassies were hit with high-power microwaves – here’s how the weapons work

The Conversation, 10 December 2020

2. ‘Sonic attacks’ suffered by US diplomats likely caused by microwave energy, government study says

CNN, 5 December 2020

48. Articles and videos - September, October 2020

References:

1. The Microwave Weapons That Could Explain Why ‘Havana Syndrome’ Report Is Not Being Released (UPDATED)

David Hambling - Forbes, 20 October 2020

2. No. 19-1289 In The Supreme Court of the United States GEORGE ANDREW BENAVIDE, PETITIONER V. UNITED STATES ATTORNEY GENEAL WILLIAM BARR, et al DEFENDANT(S)

George Andrew Benavide, 15 October 2020

49. An Assessment of Illness in U.S. Government Employees and Their Families at Overseas Embassies - 2020

From [1]:

'Military personnel (in Eurasian communist countries) exposed to non-thermal microwave radiation were said to have experienced headache, fatigue, dizziness, irritability, sleeplessness, depression, anxiety, forgetfulness, and lack of concentration, as well as internal sound perception for frequencies between 2.05-2.50 GHz (Adams and Williams, 1976).'

'The areas near the ear were most sensitive to these RF exposures; modulating the RF energy could produce a variety of effects including the perception of "buffeting of the head" or pressure on the face/head without dizziness or nausea, a "pins and needles sensation," and a sound described as a "buzz, clicking, hiss, or knocking" within the head for RF frequencies between 0.4-3 GHz, depending on pulse width, pulse-repetition frequency (PRF), and peak power density (Frey, 1962).'

'The committee finds that many of the acute, sudden-onset, early phase signs, symptoms and observations reported by DOS employees are consistent with RF effects. In addition, many of the chronic, nonspecific symptoms are also consistent with known RF effects, such as dizziness, headache, fatigue, nausea, anxiety, cognitive deficits, and memory loss. It is not necessary for RF energy sources to produce gross structural damage to cause symptoms. Rather, as with the Frey effect or potential thermoelastic pressure waves, RF sources may trigger symptoms by transiently inducing alterations in brain functioning.'

'Recommendation 3-A. If research or assessments support the possibility of radio frequency (RF) energy as a cause of illness experienced by some of its employees, the Department of State should train and equip employees with the capability to measure and characterize their exposure to RF energy in real time should the need arise in the future.'

Peter Mooring note: 'pins and needles sensation'. I wrote this in 2010: 'It started (in 2006) with an electrical shower, that is the way it felt.'

References:

1. [An Assessment of Illness in U.S. Government Employees and Their Families at Overseas Embassies](#)
National Academy of Sciences, 2020

50. CIA agents suspect they were attacked with microwave weapon in Australia - 2019

From [3]:

'While in their hotel rooms in Australia, both of the Americans felt it: the strange sound, the pressure in their heads, the ringing in their ears. According to these sources, they became nauseous and dizzy. They then traveled on to Taiwan to meet with intelligence officials there. They felt it again while in their hotel rooms on the island.'

Peter Mooring note: 'While in their hotel rooms'. This means that the attacks go through wall and/or through glass and/or through wood (door). It would be incredibly stupid to build such a weapon into the television in their room. This could easily be disassembled.

References:

1. [CIA agents suspect they were attacked with microwave weapon in Australia | ABC News](#)
ABC News (Australia), 22 October 2020
2. [Russia suspected of Cold War-style microwave attack on CIA agents in Australia](#)
ABC News (Australia), 21 October 2020
3. [The Mystery of the Immaculate Concussion](#)
CQ, 19 October 2020

51. The US military is developing a wearable 'RF weapon' exposure sensor - 2019

References:

1. [The US military is developing a wearable 'RF weapon' exposure sensor](#)
QinetiQ, 17 September 2019

52. Havana Syndrome Among Canadian Diplomats: Brain Imaging Reveals Acquired Neurotoxicity - 2019

References:

1. [Advanced Neuroimaging Shows Brain Matter Alterations in U.S. Government Personnel Who Developed Neurological Symptoms in Cuba](#)
Alon Friedman, Cynthia Calkin, Amanda Adams, et al., September 2019

53. Advanced Neuroimaging Shows Brain Matter Alterations in U.S. Government Personnel Who Developed Neurological Symptoms in Cuba - 2019

References:

1. [Advanced Neuroimaging Shows Brain Matter Alterations in U.S. Government Personnel Who Developed Neurological Symptoms in Cuba](#)
Penn Medicine News, 23 July 2019

54. Is an invisible weapon targeting U.S. diplomats? - 2019

Good summary video including not only CBS News lead producers Michael Rey, and Oriana Zill de Granados, but also many diplomats they interviewed.

References:

1. [Is an invisible weapon targeting U.S. diplomats? \(video\)](#)
CBC News, 17 March 2019
2. [Is an invisible weapon targeting U.S. diplomats?](#)
CBC News, 17 March 2019

55. Canadian Cuba diplomats sue Ottawa for \$28M over health ailments during Cuba postings - 2019

References:

1. [The Havana Syndrome, Part 4: What it could be and how experts will try to crack the case](#)
Ottawa Citizen, 27 February 2019
2. [The Havana Syndrome, Part 3: Insiders say ordeal has 'struck a nerve' in Canada's diplomatic community](#)
Ottawa Citizen, 27 February 2019
3. [Havana Syndrome, Part 2: How a dog's brain may help solve the mystery of Canadian diplomats' Cuban nightmare](#)
Ottawa Citizen, 27 February 2019
4. [The Havana Syndrome: Why Canadian diplomats have accused their government of abandoning them](#)
Ottawa Citizen, 25 February 2019
5. [Canadian diplomats sue Ottawa for handling of 'Havana Syndrome' during Cuba postings](#)
CBC News, 8 Februari 2019
6. [Diplomats sue Ottawa for \\$28M over health ailments during Cuba postings](#)
CBC News, 6 Februari 2019
7. [Canadian Lawsuit Complaint T-238-19 John Doe, Et Al v Hmq or here \(from stopeg.com\)](#)
6 Februari 2019

56. Articles and videos - November, December 2018

References:

1. [Doctors Who First Saw U.S. Diplomats Hurt In Cuba Say Symptoms 'Cannot Be Faked' | NBC News](#)
NBC News, 12 December 2018

57. Articles and videos - September, October 2018

References:

1. [Evacuated after 'health attacks' in Cuba and China, diplomats face new ordeals in U.S.](#)
NBC News, 29 October 2018

58. Articles and videos - May, June 2018

References:

1. [EXCLUSIVE: Doctors Reveal Details of Neuro-Weapon Attacks in Havana](#)
NBC News, 9 June 2018

59. Diplomat leaves post in China after reporting Havana Syndrome symptoms - 2018

1. ["60 Minutes" speaks with survivor of mysterious health attack in China](#)
NBC News, 18 March 2019
2. [Mother of U.S. diplomat hurt in 'health attack' speaks out](#)
NBC News, 20 November 2018
3. [Evacuated after 'health attacks' in Cuba and China, diplomats face new ordeals in U.S.](#)
NBC News, 29 October 2018

60. Articles and videos - November, December 2017

References:

1. [Uzbekistan incident raises suspicions of Russian involvement in Cuba attacks](#)
CBS News, 28 November 2017

61. Former CIA agent Marc Polymeropoulos victim of microwave weapon in Moscow - 2017

From [6]:

"I was awoken in the middle of the night," recalled Polymeropoulos, 51. "I just had incredible vertigo, dizziness. I wanted to throw up. The room was spinning. I couldn't even stand up without falling down. I had tinnitus ringing in my ears." He suspected a bad case of food poisoning and carried on with his 10-day trip. The visit included meetings with senior Russian intelligence officials, a common practice despite the long history of tense relations between the two countries and their spy agencies. But a second bout hit a few days later. Polymeropoulos canceled his remaining meetings and felt fortunate to make it back onto a plane to the U.S.'

References:

1. [Retired CIA Officer Finally Gets Treatment For Symptoms Of Havana Syndrome](#)
npr, 16 June 2021
2. [After 26 years with the CIA, I had silent wounds](#)
CNN, 16 March 2021
3. [Experts: Former CIA agent victim of microwave weapon in Moscow](#)
CNN, 25 February 2021
4. [How radio frequency waves ended a CIA officer's career](#)
PBS NewsHour, 12 December 2020
5. [Maddow Talks To Ex-Senior CIA Official About His Ordeal After Directed Energy Weapons Attack](#)
MSNBC, 12 December 2020
6. [A CIA Officer Visits Moscow, Returns With Mysterious, Crippling Headaches](#)
npr, 27 October 2020

62. Canadian Cuba embassy staff attacks - 2017, 2018

Five Canadian diplomats and members of their families who fell victim to mysterious health complaints while posted to Cuba are suing the Canadian government for \$28 million in damages.

From [1]:

"They downplayed everything," said Diplomat Allen, who said he and his family are still suffering from a range of strange symptoms: his wife and son have developed vision problems; and he suffers from unexplained nausea and dizziness that months of physiotherapy haven't fixed. One of his sons began blacking out for no identifiable reason while in Cuba, he said, and suffered another fainting episode in 2019 that saw him taken to hospital.'

From [3]:

(1 June 2017) "'That sound lasted 20 to 30 minutes, and I couldn't find where it was coming from – then it faded, grew slower in pace and lower in frequency, and then I felt like I was going to throw up – I had the most overwhelming nausea," the middle-aged Canadian official said in an interview this week. He got through it, dozed off briefly and then was awoken again when his wife entered the bedroom carrying their oldest child, who was covered in blood. At around the same time his father had been experiencing what he called the loud noises, the child had suffered a "massive" nose bleed – "there was blood everywhere in his room.'"

Peter Mooring note: important: 'at around the same time'. In other words, the attacks are synchronized.

References:

1. [Canadian embassy staff warned to stay silent on "Havana Syndrome"](#)
Global News, 26 October 2020
2. [Blood and bureaucracy: Inside Canada's panicked response to 'Havana syndrome'](#)
The Globe and Mail, 12 December 2018
3. [Canada's brain-injured Cuba diplomats speak out about Ottawa's silence](#)
The Globe and Mail, 18 November 2018

63. USA Cuba embassy staff attacks (2016-2018)

From [2]

'Many of the officers suffered from dizziness, fatigue, headaches, and loss of hearing, memory and balance, and some were forced into permanent retirement.'

From [3]:

'Reported facts appear consistent with pulsed RF/MW as the source of injury in affected diplomats. Nondiplomats citing symptoms from RF/MW, often with an inciting pulsed-RF/MW exposure, report compatible health conditions. Under the RF/MW hypothesis, lessons learned for diplomats and for RF/MW-affected civilians may each aid the other.'

From [6]:

'The Navy sought to paralyze. The Frey effect was to induce sounds powerful enough to cause painful discomfort and, if needed, leave targets unable to move. The weapon, the Navy noted, would have a "low probability of fatalities or permanent injuries."'

'James C. Lin of the University of Illinois, a leading investigator of the Frey effect, described the diplomatic ills as plausibly arising from microwave beams.'

References:

1. [Havana syndrome](#)
Wikipedia
2. [Report Points to Microwave 'Attack' as Likely Source of Mystery Illnesses That Hit Diplomats and Spies](#)
New York Times, 5 December 2020
3. [Diplomats' Mystery Illness and Pulsed Radiofrequency/Microwave Radiation](#)
Beatrice Alexandra Golomb, 30 November 2018
4. [The Mystery of the Havana Syndrome](#)
The New Yorker, 9 November 2018
5. [Declassified - Diplomats' Mystery Illness and Pulsed Radiofrequency/Microwave Radiation](#)
JASON, November 2018
6. [Scientists say 'neuroweapons' were behind Cuba attacks](#)
Yahoo! News, 10 September 2018

7. [Microwave Weapons Are Prime Suspect in Ills of U.S. Embassy Workers](#)

New York Times, 1 September 2018

8. [How an Alleged Sonic Attack Shaped U.S. Policy on Cuba | Times Documentaries](#)

The New York Times, 18 April 2018

9. [This Is the Sound American Diplomats Heard During Sonic Attacks In Havana, Cuba | TIME](#)

Time, 12 October 2017

64. USA Consulate Guangzhou, China, staff attacks - 2016, 2017

From [2]:

'The situation in Guangzhou is eerily reminiscent of an episode in Havana, where, starting in the fall of 2016, at least 24 staffers at the U.S. Embassy incurred brain injuries after exposure to an equally mysterious source.'

References:

1. [Opinion: A diplomat's mysterious illness could jeopardize China's relationship with the U.S.](#)

Washington Post, 6 June 2018

65. Russia's zombie ray gun program - 2012

From [4]:

Sources in Moscow say Mr Putin has described the guns, which use electromagnetic radiation like that found in microwave ovens, as 'entirely new instruments for achieving political and strategic goals'.

Mr Putin added: 'Such high-tech weapons systems will be comparable in effect to nuclear weapons, but will be more acceptable in terms of political and military ideology.'

Plans to introduce the super- weapons were announced quietly last week by Russian defence minister Anatoly Serdyukov, fulfilling a little-noticed election campaign pledge by president-elect Putin.

Mr Serdyukov said: 'The development of weaponry based on new physics principles – direct-energy weapons, geophysical weapons, wave-energy weapons, genetic weapons, psychotronic weapons, and so on – is part of the state arms procurement programme for 2011-2020.'

Specific proposals on developing the weapons are due to be drawn up before December by a new Defence Advanced Research Projects Agency.

Research into electromagnetic weapons has been secretly carried out in the US and Russia since the Fifties. But now it appears Mr Putin has stolen a march on the Americans. Precise details of the Russian gun have not been revealed. However, previous research has shown that low-

frequency waves or beams can affect brain cells, alter psychological states and make it possible to transmit suggestions and commands directly into someone's thought processes.

High doses of microwaves can damage the functioning of internal organs, control behaviour or even drive victims to suicide. Anatoly Tsyganok, head of the Military Forecasting Centre in Moscow, said: 'This is a highly serious weapon.'

'When it was used for dispersing a crowd and it was focused on a man, his body temperature went up immediately as if he was thrown into a hot frying pan. Still, we know very little about this weapon and even special forces guys can hardly cope with it.'

The long-term effects are not known, but two years ago a former major in the Russian foreign intelligence agency, the GRU, died in Scotland after making claims about such a weapons programme to MI6. Sergei Serykh, 43, claimed he was a victim of weapons which he said were 'many times more powerful than in the Matrix films'. Mr Serykh died after falling from a Glasgow tower block with his wife and stepson in March 2010. While his death was assumed to be suicide, his family fear there was foul play. Last night the Ministry of Defence declined to comment

1. [The USSR spent \\$1B on mind-control programs](#)

New York Post, 28 December 2013

2. [Reality check on Russia's 'zombie ray gun' program](#)

NBC News, 7 April 2012

3. [Are We Ready for the Russian Zombie Gun?](#)

Forbes, 4 April 2012

4. [Putin targets foes with 'zombie' gun which attack victims' central nervous system](#)

MailOnline, 1 April 2012

5. Following article is from 2007:

[Russians have psychotronic weapon to zombie people](#)

Pravda, 14 August 2007

66. Unclassified - Bioeffects of Selected Nonlethal Weapons - 2006

Through a FOIA request, Donald Friedman received in 2006 the document 'Bioeffects Of Selected Non-Lethal Weapons' from the Department of the Army. This document describes in detail the effects on the human body when applying laser light, radio frequency directed energy, and bio sound effects:

- microwaves:
 - microwave heating
 - microwave hearing
 - disruption of neural control including a sudden loss of consciousness and intense muscle spasms
- acoustic energy:

- severe pressure sensations
- involuntary motion of the eyes
- nausea and seeing his surroundings turning around him
- lasers:
 - dazzling or induced glare
 - flashblinding or loss of night adaptation
 - permanent or semipermanent blinding

References:

1. Unclassified - Bioeffects of Selected Nonlethal Weapons
DEPARTMENT OF THE ARMY, 13 December 2006

67. The film 'Control Factor' (2003)

In January 2003 (!) the film 'Control Factor' was released. The main character Lance was hearing voices that told him to murder his wife Karen. Later in the film his wife appeared to be an agent, her real name in the film was **Medusa**.

My, what a coincidence:

- MEDUSA
MEDUSA (weapon) Wikipedia
- MEDUSA (Mob Excess Deterrent Using Silent Audio)
Microwave ray gun controls crowds with noise
NewScientist, 2008

In the 'Control Factor' film, the important scene starts at minute 40 where Lance shoots his wife Karen because the voices tell him to do this. Then Karen gets up and talks to her watch:

Karen: Control, this is Medusa.

Control: Go ahead Medusa, status update ...

Medusa: Subject has been compromised.

Lance: Karen ...

Medusa: You failed the test.

Few moments later, in the mind control room:

Woman: Sir, the director is on the line for you.

Mind controller: Good evening director.

Director: I trust things are in order?

Mind controller: Yes, the test was a success. It seems that the resolve of a man is no stronger than the neurons firing in his brain.

Director: What is his status?

Mind controller: There is increased signs of stress in his cerebral cortex, some alpha spikes, but otherwise his brain tissue remains healthy.

Director: How about long term side effects, microwaves?

Mind controller: Not that we can see.

Director: And that would hold too for everyone?

Mind controller: Well it should, technology is quite harmless.

A moment later the conversation goes on:

Medusa: When you start phase two, what happens then?

Mind controller: Well, we will expand, from individuals to a larger population.

The technology may also be related to the following patent, mentioned by Giordano and Schamiloglu, filed in 2005. This is through-wall technology and very targeted. Used for 'hearing and equilibrium disruption', which causes all kinds of effects. Perhaps, you can modulate voices as well.

- ELECTROMAGNETIC PERSONNEL INTERDICTION CONTROL METHOD AND SYSTEM
United States Patent No.: US 7.841,989 B2
Filed: 2005
- Non-lethal Electromagnetic Stand-off Weapon
Invocon, Inc.

References:

1. Control Factor (2003) - Part 1
Control Factor (2003) - Part 1

68. Mike Beck, a former NSA counterintelligence officer suspected he was exposed to microwave attacks - 1999

From [2]:

'Mike Beck, a former National Security Agency counterintelligence officer, who suspected that he was exposed to microwave attacks, while on an overseas assignment with a partner in 1996. Both men later developed Parkinson 's disease.'

From [3]:

'The National Security Agency confirms that there is intelligence information from 2012 associating the hostile country to which Mr. Beck traveled in the late 1990s with a high-powered microwave system weapon that may have the ability to weaken, intimidate, or kill an enemy over time and without leaving evidence. The 2012 intelligence information indicated that this weapon is designed to bathe a target's living quarters in microWaves, causing numerous physical effects, including a damaged nervous system. The National Security Agency has no evidence that such a weapon, if it existed and if it was associated with the hostile country in the late 1990s, was or was not used against Mr. Beck.'

Peter Mooring note: 'intelligence information ... associating the hostile country ... in the late 1990s with a high-powered microwave system weapon'. This more or less means that these weapons were used already in the 1990's.

Peter Mooring note: 'bathe a target's living quarters in microwaves, causing numerous physical effects'. This means not only that these weapons go through, glass, walls, wood, but that they are powerful enough to cause serious damage to a human.

References:

1. [After 26 years with the CIA, I had silent wounds](#)
The Guardian, 2 May 2021
2. [Was a spy's Parkinson's disease caused by a secret microwave weapon attack?](#)
Washington Post, 5 December 2017
3. [Unclassified](#)
National Security Agency (NSA), 16 October 2014

69. Wonder Weapons - 1997

In 1997, U.S News and World Report published an article 'Wonder Weapons' that reveals that the U.S. had research projects:

- to incapacitate people without inflicting lethal injuries
- to affect human behavior
- to blind enemy soldiers. to stun them, nauseate them, or even "liquefy their bowels and reduce them to quivering diarrhetic messes,"
- to incapacitate the central nervous system remotely
- to make internal organs resonate (The effects can run from discomfort to damage or death)
- to induce epilepticlike seizures
- to heat the body to bring on discomfort, fevers, or even death
- to alter sleep patterns
- and more

using lasers, acoustics and microwaves.

From the article:

Weapons already exist that use lasers, which can temporarily or permanently blind enemy soldiers. So-called acoustic or sonic weapons, like the ones in the aforementioned lab, can vibrate the insides of humans to stun them, nauseate them, or even "liquefy their bowels and reduce them to quivering diarrhetic messes," according to a Pentagon briefing. Prototypes of such weapons were recently considered for tryout when U.S. troops intervened in Somalia. Other, stranger effects also have been explored, such as using electromagnetic waves to put human targets to sleep or to heat them up, on the microwave-oven principle. Scientists are also trying to make a sonic cannon that throws a shock wave with enough force to knock down a

man. While this and similar weapons may seem far-fetched, scientists say they are natural successors to projects already underway—beams that disable the electronic systems of aircraft, computers, or missiles, for instance. “Once you are into these antimateriel weapons, it is a short jump to antipersonnel weapons,” says Louis Slesin, editor of the trade journal *Microwave News*. That’s because the human body is essentially an electrochemical system, and devices that disrupt the electrical impulses of the nervous system can affect behavior and body functions. But these programs—particularly those involving antipersonnel research—are so well guarded that details are scarce. “People [in the military] go silent on this issue,” says Slesin, “more than any other issue. People just do not want to talk about this.”

...

The military is looking for something less benign—an acoustic weapon with frequencies tunable all the way up to lethal. Indeed, Huntington Beach-based Scientific Applications & Research Associates Inc. (SARA) has built a device that will make internal organs resonate: The effects can run from discomfort to damage or death. If used to protect an area, its beams would make intruders increasingly uncomfortable the closer they get. “We have built several prototypes,” says Parviz Parhami, SARA’s CEO.

...

In the mid-1940s, the U.S. Navy created a program called Project Squid to study the German vortex technology. The results are unknown. But Guy Obolensky, an American inventor, says he replicated the Nazi device in his laboratory in 1949. Against hard objects the effect was astounding, he says: It could snap a board like a twig. Against soft targets like people, it had a different effect. “I felt like I had been hit by a thick rubber blanket,” says Obolensky, who once stood in its path. The idea seemed to founder for years until recently, when the military was intrigued by its nonlethal possibilities. The Army and Navy now have vortex projects underway. The SARA lab has tested its prototype device at Camp Pendleton, one source says.

...

The Soviets were known to have potent blinding lasers. They were also feared to have developed acoustic and radio-wave weapons. The 1987 issue of *Soviet Military Power*, a cold war Pentagon publication, warned that the Soviets might be close to “a prototype short-range tactical RF [radio frequency] weapon.” The *Washington Post* reported that year that the Soviets had used such weapons to kill goats at 1 kilometer’s range. The Pentagon, it turns out, has been pursuing similar devices since the 1960s.

...

“We were looking at electrical activity in the brain and how to influence it,” he says. Byrd, a specialist in medical engineering and bioeffects, funded small research projects, including a paper on vortex weapons by Obolensky. He conducted experiments on animals—and even on himself—to see if brain waves would move into sync with waves impinging on them from the outside.

...

“The work was really outstanding,” he grumbles. “We would have had a weapon in one year.” Byrd says he was told his work would be unclassified, “unless it works.” Because it worked, he suspects that the program “went black.” Other scientists tell similar tales of research on electromagnetic radiation turning top secret once successful results were achieved. There are

clues that such work is continuing. In 1995, the annual meeting of four-star U.S. Air Force generals—called CORONA—reviewed more than 1,000 potential projects. One was called “Put the Enemy to Sleep/Keep the Enemy From Sleeping.” It called for exploring “acoustics,” “microwaves,” and “brain-wave manipulation” to alter sleep patterns. It was one of only three projects approved for initial investigation.

References:

- [Wonder Weapons](#), or [here](#), or [here](#)
U.S News and World Report, 7 July 1997

70. Greenham Common women peace activists claim being attacked with microwaves - 1986

From [1], article is not available online:

Peace women fear electronic zapping at base

By Sarah Perry

secret electronic signals
satellite communications

Doctors are compiling a report on the condition of a number of Greenham Common peace women who have had symptoms which are consistent with the known neurophysiological effects of electromagnetic waves, or low level radiation.

These symptoms range from headache and dizziness to difficulties of concentration or memory. Fears of electronic "zapping" have led peace women at the camp to keep a record of ill-effects reported by their groups over the past year.

Claims that this has revealed a pattern of illness will be presented by the peacewomen at a media briefing in London today. They will report that at least 40 women present at different points around the nine-mile perimeter of the American cruise missile base have experienced similar symptoms, at the same times.

Dr. Stephen farrow, chairman of the Medical Campaign Against Nuclear weapons said yesterday: 'We are now compiling evidence about the claims made by the women. There is obviously a great deal of interest in what they say; it seem feasible, although a lot of it is anecdotal, and we'le very thin on evidence.'

Dr. farrow, who is senior lecturer in epidemiology at the University College of Wales Medical College said that academic research into similar claims was being conducted in Canada.

The symptoms could be related to the powerful and secret electronic microwave satellite communications apparatus used at the missile base. If this is so, it would indicate unhealthy

emissions are being radiated into the Berkshire countryside.

On the other hand the American military have an intruder detection system called BISS, Base Installation Security system which operates on a sufficiently high frequency to bounce radar waves off a human body moving in the vicinity of a perimeter fence.

A similar British system has been developed and has been acquired by the Ministry of Defence since April, 1984. Security at Greenham is a British responsibility but it is not known whether equipment of this type has been installed.

Some Greenham women believe that the symptoms are the result of an attempt to drive them away from their protest siege of the missile base.

Other peace women claim they are being assaulted by what the military calls electronic warfare, as part of a 'field trial.'

The Greenham women claim that meter tests outside camp, taken at times when women have experienced the symptoms, have shown a marked increase in background microwave signal levels. they also say the symptoms are more pronounced when cruise missile convoys leave the camp.

The Ministry of Defence denies that any form of electronic signals are being use on the women.

References:

1. [Peace women fear electronic zapping at base](#)
The Guardian, 10 March 1986

71. USA Moscow embassy staff microwaving - 1976

References:

1. [SOVIET DIMS BEAM AT U.S. EMBASSY](#)
New York Times, 8 July 1976
2. [Soviet Halts Microwaves Aimed at U.S. Embassy](#)
New York Times, 30 May 1979
3. [Russia targets American diplomats with new directed energy weapon](#)
Robert Lansing Institute, 18 May 2021

72. Laws prohibiting attacks with electromagnetic waves

From [1]:

""Laws against electronic harassment — Electronic harassment is a term referring to the use of electronic devices to harass, torture, and/or physically harm a person, not to be confused with cyberstalking. Laws against electronic harassment:

(1) Michigan — Public act 257 of 2003 makes it a felony for a person to "manufacture, deliver, possess, transport, place, use, or release" a "harmful electronic or electromagnetic device" for "an unlawful purpose"; also made into a felony is the act of causing "an individual to falsely believe that the individual has been exposed to a...harmful electronic or electromagnetic device."

(2) Maine — Public law 264, H.P. 868 — L.D. 1271 criminalizes the knowing, intentional, and/or reckless use of an electronic weapon on another person, defining an electronic weapon as a portable device or weapon emitting an electrical current, impulse, beam, or wave with disabling effects on a human being.

(3) Massachusetts — Chapter 170 of the Acts of 2004, Section 140 of the General Laws, section 131J states: "No person shall possess a portable device or weapon from which an electrical current, impulse, wave or beam may be directed, which current, impulse, wave or beam is designed to incapacitate temporarily, injure or kill, except ... Whoever violates this section shall be punished by a fine of not less than \$500 nor more than \$1,000 or by imprisonment in the house of correction for not less than 6 months nor more than 2 1/2 years, or by both such fine and imprisonment." (Wikipedia)"

1. [States that have electronic harassment penal codes](#)

Reddit, 2016

2. [Richmond Resolution On Space-Based Weaponry Prompts Flood Of Calls To Police From 'Targeted Individuals'](#)

CBS SF Bay Area, 1 June 2015

73. Related documents: Medical

Documents:

- [Acute Findings in an Acquired Neurosensory Dysfunction](#)

Michael E. Hoffer, MD; Bonnie E. Levin, PhD; Hillary Snapp, AuD, PhD; James Buskirk, PT, SCS; Carey Balaban, PhD, 2018

74. Related documents: Books and websites

Documents:

- [Targeted Individuals Data & Documents](#)

- [Active Denial System FAQs](#)

Joint Intermediate Force Capabilities Office

- [BIOETHICS COMMISSION Letter Stating They Will Not Investigate Claims by Targeted Individuals](#)

27 July 2011

- BIOLOGICAL EFFECTS OF ELECTROMAGNETIC RADIATION (RADIOWAVES AND MICROWAVES - EURASIAN COMMUNIST COUNTRIES
DEFENSE INTELLIGENCE AGENCY, March 1976
- The European Parliament adopted a resolution on January 28, 1999[38], 28.1.99 Environment, security and foreign affairs A4-0005/99:
 - 23. Calls on the European Union to seek to have the new 'non-lethal' weapons technology and the development of new arms strategies also covered and regulated by international conventions ...
 - 27. Calls for an international convention introducing a global ban on all developments and deployments of weapons which might enable any form of manipulation of human beings
- DIRECTED ENERGY WEAPONS ON THE BATTLEFIELD: A NEW VISION FOR 2025
John P. Geis, II, Lieutenant Colonel, USAF, April 2003
- "The Design and Fabrication of a Damage Inflicting RF Weapon by 'Back Yard' Methods"
John P. Geis, II, Lieutenant Colonel, USAF, April 2003
- S.2778 - Directed Energy Weapon Systems Acquisition Act of 2016
1998 Congressional Hearings Intelligence and Security
Statement of Mr. David Schriener before the Joint Economic Committee United States Congress
25 February 1998
- BY ORDER OF THE COMMANDER AIR FORCE RESEARCH LABORATORY (AFRL)
AIR FORCE RESEARCH LABORATORY INSTRUCTION 40-402
PROTECTION OF HUMAN SUBJECTS IN RESEARCH
21 APRIL 2016
Certified Current, 13 September 2018
Medical Command
- weapons_docs_v20150616.pdf
STOPEG, 2015
- CAHRA
Russian Book Translation Project Results
With related background information on Russian/U.S. mind control technology
Mind Justice, September 2001
- Presentation submitted to the Senate Hearing on 'The State of Civil and Human Rights in the United States'
Dr. Daniel Lebowitz, 9 December 2014
- One Year Ago — Havana Syndrome — CIA Report : "No Worldwide Campaign by Foreign Adversary" [UPDATE — MIND CONTROL RELATED TECHNOLOGY U.S. PATENTS]
Intel Today, 20 January 2023
- Havana Syndrome — CIA Report : "No Worldwide Campaign by Foreign Adversary" [UPDATE — U.S. officials report injuries on White House grounds]
Intel Today, 22 February 2022
- Havana Syndrome — What Are the Frequencies Used by US Intel for Microwave Spying? [UPDATE : Snowden doc reveals joint NSA/GCHQ project and corroborates Intel

Today's Analysis]

Intel Today, 11 December 2022

- Havana Syndrome — The Haiku Master, the Cicadas and the CIA [UPDATE : DNI Statement on the Intelligence Community Assessment (March 1, 2023)]

Intel Today, 2 March 2023

- UTILIZING 5G HAS ENORMOUS SURVEILLANCE CAPABILITIES AND WILL BE ABUSED AT THE WHIM OF LAW ENFORCEMENT AND THE INTELLIGENCE ESTABLISHMENT. MILLIMETER WAVE IS THE SAME FREQUENCY USED BY AIRPORT SCANNERS TO SEE BEYOND CLOTHES TO THE NAKED BODY. THIS FREQUENCY HAS THE SAME CAPABILITY WHEN DIRECTED TOWARDS THE WALLS SURROUNDING HOMES. IT ENABLES A VIEW INSIDE THE HOME WHERE MOVEMENTS AND ACTIVITIES OF THE PEOPLE INSIDE CAN BE OBSERVED. IT WILL BE ABLE TO PROVIDE NOT ONLY DATA ABOUT MOVEMENT INSIDE THE HOME BUT WHAT PRODUCTS PEOPLE ARE USING. THIS IS A MASSIVE CRIME AGAINST HUMANS, ANIMALS AND SHOULD BE STOPPED BY WHATEVER MEANS POSSIBLE. PEOPLE NEED TO EDUCATE THEMSELVES AND OTHERS AS TO WHAT THE 5G MILLIMETER WAVE ROLL OUT WILL MEAN TO ALL OF SOCIETY. MILLIMETER WAVE (5G) AND MICROWAVE MIND CONTROL

Tim Rifat

- Electromagnetic harassment with torturous patterns (electromagnetic torture, cybernetic torture or cybertorture): "the crime that people complain most about on the internet/social media"

Relevance to neuroweapons as well as "Health Attacks" or "Health Incidents" of U.S. and Canada diplomats

Document on the website of The Office of the United Nations High Commissioner for Human Rights (OHCHR)

- The development of new anti-personnel weapons

Louise Doswald-Beck and Gerald C. Cauderay - International Review Of the Red Cross Nov-Dec 1990

- voice to skull devices (or here)

Page on <http://call.army.mil/products//thesaur/00016275.htm> that was removed after January 2004.

- Communicating Via the Microwave Auditory Effect

1995

Abstract: In this research program, we plan to investigate a revolutionary new form of communication based on the microwave auditory effect. This proposed communication idea satisfies the requirements for an innovative, natural interface requiring no learning or training for efficient operation and effective communications. The purpose of the program proposed here is to extend the results of a recent feasibility study, performed for the Armstrong Laboratory/OEDR. The study found that voice communications, via the microwave auditory effect, are highly feasible. In Phase I of this SBIR, we propose to investigate the range of potential applications for this radically different form of voice communication and recommend hardware and systems concepts suitable for laboratory and brassboard demonstrations to be built under Phase II.

- [Report: Nonlethal Weapons Could Target Brain, Mimic Schizophrenia \(or here\)](#)
Wired, 10 February 2008

Books:

- [The Hidden Evil: The Financial Elite's Covert War Against The Civilian Population \(on Amazon\)](#)
Mark Rich
- [New World War: Revolutionary Methods for Political Control \(on Amazon\)](#)
Mark Rich
- [How to Tame a Demon: A short practical guide to organized intimidation stalking, electronic torture, and mind control \(on Amazon\)](#)
Robert Duncan

Websites:

- www.stopeg.com
STOPEG (STOP Electronic weapons and Gangstalking) - Peter Mooring
- www.newworldwar.org
New World War - Mark Rich
- www.e-waffen.de
Initiative gegen elektromagnetische Folter - Harald Brems
- www.covertharassmentconference.com
COVERT HARASSMENT CONFERENCE 2015
- www.electronic torture.com
Electronic torture, Electromagnetic torture, Microwave torture, Electronic murder, Electromagnetic murder, Microwave murder, Organized murder, Cooked alive, Electronic mind control, Electronic mind reading, Brain zapping, People zapper
- www.peoplecooker.com
PEOPLECOOKER.COM

75. Articles in Dutch

Below a selection of articles that appeared in the main stream media in The Netherlands.

- [Mysterieus Havanasyndroom niet veroorzaakt door vijandige krachten, zeggen Amerikaanse autoriteiten](#)
NRC, 2 maart 2023
- [Mysterieus Havana-syndroom onder Amerikanen 'hoogstwaarschijnlijk' niet veroorzaakt door vijandelijke macht](#)
Volkskrant, 2 maart 2023
- [Amerikaanse geheime diensten geven min of meer toe: 'Havana-syndroom' bestaat niet](#)
Trouw, 1 maart 2023
- [Inlichtingendiensten VS: Havanasyndroom niet buitenlands of buitenaards](#)
nu.nl, 1 maart 2023

- Inlichtingendiensten VS: Mysterieus Havana-syndroom niet buitenlands of buitenaards
Algemeen Dagblad, 1 maart 2023
- Mysterieus Havanasyndroom duikt weer op, nu bij diplomaten in Colombia
RTL Nieuws, 13 oktober 2021
- Onderzoek naar mysterieus 'Havana-syndroom' levert weinig op
Telegraaf, 9 augustus 2021
- Onderzoek gestart na symptomen van 'Havana-syndroom' bij Amerikaanse diplomaten in Wenen
Volkskrant, 19 juli 2021
- Oostenrijk en VS onderzoeken mysterieuze klachten Amerikaanse diplomaten in Wenen
AD, 19 juli 2021
- Onderzoek naar Havana-syndroom diplomaten in Wenen
NOS, 18 juli 2021
- Onderzoek naar Havana-syndroom diplomaten in Wenen
NOS, 18 juli 2021
- Cubaanse pulsen of hysterie van de VS
NRC, 18 december 2020
- 'Radiosignalen maakten Amerikaanse diplomaten ziek'
Trouw, 6 december 2020
- Microgolven waarschijnlijke oorzaak mysterieuze ziekte Amerikaanse diplomaten op Cuba
RTL Nieuws, 6 december 2020

76. Contact

Please use the information below to contact me.

Peter Mooring / STOPEG Foundation
 E: peterpm@xs4all.nl / info@stopeg.com
 M: +31 6 4124 3030
 Buys Ballotstraat 40
 4631 GW Hoogerheide
 The Netherlands

Copyright 2020-2024 Peter Mooring. All rights reserved.